

HERACLES

HEritage **R**esilience **A**gainst **CL**imate **E**vents on **S**ite

Deliverable D3.1

Definition of a systematic protocol related to the diagnostic and analytical strategies for each different monument to be studied on the basis of the different structures, materials and weathering states

Version: V2.0

Project details:	
No:	700395
Name:	HERACLES
Title:	HEritage Resilience Against CLimate Events on Site
Start date:	May 1st, 2016
Duration:	36 month



Dissemination Level		
PU	Public	•
PP	Restricted to other programme participants (including the Commission Services)	
RE	Restricted to a group specified by the consortium (including the Commission Services)	
CO	Confidential, only for members of the consortium (including the Commission Services)	

Document details:	
Project	HERACLES
Title	Deliverable D.3.1: Definition of a systematic protocol related to the diagnostic and analytical strategies for each different monument to be studied on the basis of the different structures, materials and weathering states
Version	2.0
Work package	WP3
Author(s)	Paraskevi Pouli, Gianfranco Fornaro, Antonella Curulli, Ilaria Catapano, George Alexandrakis, George Kozyrakis, Filippo Ubertini, Anna Laura Pisello, Nicola Cavalagli, Veronica Lucia Castaldo, Marco Folegani, Clemens Rendl, Joao Pedro Veiga, Diego Reale, Francesco Trillo, Gabriele Murchio, Kostas Hatzigiannakis, Eliza Kavoulaki, Elpida Politaki, Angeliki Psaroudaki, Kostas Demadis, Giannis Grammatikakis
Keywords	Systematic Protocol, Diagnostic and analytical strategies, Structure, materials and Weathering states
Document ID	HERACLES: Definition of a systematic protocol related to the diagnostic and analytical strategies for each different monument to be studied on the basis of the different structures, materials and weathering states D.3.1_v 1.0
Synopsis	Report for Work Package 3
Release Date	09/06/2017





Revision history:			
Version	Date	Changes	changes by
0.1	February 15 th , 2017	Draft version	Gianfranco Fornaro
0.2	March 3 rd , 2017	Draft version	Antonella Curulli, Ilaria Catapano,
0.3	March 10 th , 2017	Draft version	Paraskevi Pouli, George Alexandrakis, Gianfranco Fornaro, Antonella Curulli
0.4	March 23 rd , 2017	Draft version	Paraskevi Pouli, George Alexandrakis, George Kozyrakis, Gianfranco Fornaro, Antonella Curulli, Filippo Ubertini, Anna Laura Pisello, Nicola Cavalagli, Veronica Lucia Castaldo, Marco Folegani, Clemens Rendl, Ilaria Catapano, Joao Pedro Veiga
0.5	March 28 th , 2017	Draft version	Paraskevi Pouli
0.6	March 30 th , 2017	Draft version	Antonella Curulli
0.7	April 5 th , 2017	Draft version	Paraskevi Pouli
0.8	April 10 th , 2017	Draft version	Gianfranco Fornaro, Ilaria Catapano, Nicola Cavalagli, Antonella Curulli, Marco Folegani, Diego Reale, Francesco Trillo, George Alexandrakis, George Kozyrakis, Kostas Hatzigiannakis, Paraskevi Pouli, Eliza Kavoulaki, Elpida Politaki, Angeliki Psaroudaki, Giannis Grammatikakis
0.9	April 20, 2017	Draft version	Antonella Curulli, Joao Pedro Veiga, Gianfranco Fornaro, Kostas Demadis, Paraskevi Pouli, Kostas Hatzigiannakis, George Alexandrakis, George Kozyrakis, Eliza Kavoulaki, Elpida Politaki, Angeliki Psaroudaki,
0.10	April 26, 2017	Draft version	Antonella Curulli, Joao Pedro Veiga, Gianfranco Fornaro, Marco Folegani, Ilaria Catapano, Kostas Demadis, Kostas Hatzigiannakis, George Alexandrakis, George Kozyrakis, Paraskevi Pouli



0.11	April 28, 2017	Draft version	Gianfranco Fornaro, Gabriele Murchio, Francesco Soldovieri
0.12	April 30, 2017	Draft version	Antonella Curulli
0.13	May 2, 2017	Draft version	Giuseppina Padeletti, G. Fornaro, Antonella Curulli, P.Pouli
0.14	May 31, 2017	Draft version	Giuseppina Padeletti, G. Fornaro, Antonella Curulli F. Ubertini, P. Pouli
1.0	June 09, 2017	Final version	Giuseppina Padeletti
2.0	March 22, 2018	Final version	G. Padeletti



Table of contents

1	Executive Summary	8
2	Introduction	9
2.1	DOCUMENT ORGANIZATION.....	9
2.2	REFERENCE DOCUMENTS	9
2.3	ACRONYMS AND ABBREVIATIONS.....	10
2.4	SCOPE & OBJECTIVES	15
2.5	RELATION WITH OTHER DELIVERABLES.....	16
3	TEST-BEDS - A brief summary	17
4	METHODS-SENSORS	18
4.1	SATELLITE/WIDE AREA SENSING	18
4.1.1	<i>Optical/VNIR Sensors.....</i>	<i>18</i>
4.1.2	<i>Multispectral Sensors.....</i>	<i>22</i>
4.1.3	<i>Synthetic Aperture Radar Sensors.....</i>	<i>29</i>
4.2	AIRBORNE/LOCAL AREA SENSING	34
4.3	IN-SITU SENSING.....	39
4.3.1	<i>GPR.....</i>	<i>40</i>
4.3.2	<i>Holographic radar.....</i>	<i>42</i>
4.3.3	<i>ERT.....</i>	<i>44</i>
4.3.4	<i>Structural monitoring sensors.....</i>	<i>47</i>
4.3.5	<i>Meteorological – Oceanographical sensors.....</i>	<i>52</i>
4.3.5.1	<i>Meteorological sensors.....</i>	<i>52</i>
4.3.5.2	<i>Oceanographic sensors.....</i>	<i>59</i>
4.4	MATERIAL CHARACTERIZATION METHODOLOGIES	61
4.4.1	<i>In-situ.....</i>	<i>65</i>
4.4.1.1	<i>Multispectral Imaging (MSI).....</i>	<i>65</i>
4.4.1.2	<i>Portable Raman</i>	<i>66</i>
4.4.1.3	<i>Portable Laser Induced Breakdown Spectroscopy (LIBS).....</i>	<i>66</i>
4.4.1.4	<i>4D surface volume topography</i>	<i>67</i>
4.4.1.5	<i>In-situ analysis/techniques for mechanical characterization</i>	<i>68</i>
4.4.2	<i>Ex-situ.....</i>	<i>69</i>
4.4.2.1	<i>Scanning Electron Microscopy (SEM-FIB with EDS).....</i>	<i>69</i>
4.4.2.2	<i>X-ray Diffraction (XRD) (also micro)</i>	<i>71</i>





4.4.2.3	X-ray fluorescence spectrometry (XRF) (also micro)	72
4.4.2.4	ThermoGravimetry-Differential Thermal Analysis (TG-DTA) and Differential Scanning Calorimetry (DSC)	73
4.4.2.5	Differential Scanning Calorimetry (DSC)	74
4.4.2.6	micro Raman spectrometry	75
4.4.2.7	Confocal Laser scanning microscopy	76
4.4.2.8	Stereo microscopy	77
4.4.2.9	Fourier Transform Infrared (FTIR) Spectroscopy	78
4.4.2.10	Ellipsometry	80
4.4.2.11	Atomic Force Microscopy (AFM)	80
4.4.2.12	Ultraviolet-visible-Near-infrared (UV-Vis-NIR) spectroscopy	82
4.4.2.13	Porosimetry (Archimedes) and helium picnometry	82
4.4.2.14	XPS	83
4.4.2.15	non-linear microscopy	86
4.4.2.16	Analyses/techniques concerning the mechanical, thermo-physical characterization of concrete, mortars, binders and stones	86
5	Definition of the systematic protocol	91
5.1	GUBBIO	95
5.1.1	Town Walls	95
5.1.1.1	Structural Issues	96
5.1.1.1.1	The aim of the diagnostic and analytical Strategy	96
5.1.1.1.2	Selected zones and elements of significance	96
5.1.1.1.3	Outline of the sensing, diagnostic and analytical methodologies	97
5.1.1.2	Materials	98
5.1.1.2.1	The aim of the diagnostic and analytical Strategy	98
5.1.1.2.2	Selected zones and elements of significance	98
5.1.1.2.3	Outline of the sensing, diagnostic and analytical methodologies	98
5.1.1.3	Systematic protocol related to the diagnostic and analytical strategies for Gubbio – Town Walls	100
5.1.2	Consoli Palace	101
5.1.2.1	Structural issues	101
5.1.2.1.1	The aim of the diagnostic and analytical Strategy	101
5.1.2.1.2	Selected zones and elements of significance	102
5.1.2.1.3	Outline of the sensing, diagnostic and analytical methodologies	102
5.1.2.2	Materials	103
5.1.2.2.1	The aim of the diagnostic and analytical Strategy	103
5.1.2.2.2	Selected zones and elements of significance	103
5.1.2.2.3	Outline of the sensing, diagnostic and analytical methodologies	104
5.1.2.3	Systematic protocol related to the diagnostic and analytical strategies for Gubbio – Consoli palace	105





5.2	HERAKLION.....	105
5.2.1	<i>Venetian sea fortress- Koules.....</i>	<i>106</i>
5.2.1.1	<i>Structural issues</i>	<i>106</i>
5.2.1.1.1	<i>The aim of the diagnostic and analytical Strategy</i>	<i>106</i>
5.2.1.1.2	<i>Selected zones and elements of significance</i>	<i>107</i>
5.2.1.1.3	<i>Outline of the sensing, diagnostic and analytical methodologies</i>	<i>107</i>
5.2.1.2	<i>Materials</i>	<i>108</i>
5.2.1.2.1	<i>The aim of the diagnostic and analytical Strategy</i>	<i>108</i>
5.2.1.2.2	<i>Selected zones and elements of significance</i>	<i>109</i>
5.2.1.2.3	<i>Outline of the sensing, diagnostic and analytical methodologies</i>	<i>109</i>
5.2.1.3	<i>Systematic protocol related to the diagnostic and analytical strategies for Heraklion – Koules fortress... 110</i>	
5.2.2	<i>Archaeological site of Knossos Palace</i>	<i>111</i>
5.2.2.1	<i>Structural issues</i>	<i>113</i>
5.2.2.1.1	<i>The aim of the diagnostic and analytical Strategy</i>	<i>113</i>
5.2.2.1.2	<i>Selected zones and elements of significance</i>	<i>113</i>
5.2.2.1.3	<i>Outline of the sensing, diagnostic and analytical methodologies</i>	<i>114</i>
5.2.2.2	<i>Materials</i>	<i>114</i>
5.2.2.2.1	<i>The aim of the diagnostic and analytical Strategy</i>	<i>115</i>
5.2.2.2.2	<i>Selected zones and elements of significance</i>	<i>115</i>
5.2.2.2.3	<i>Outline of the sensing, diagnostic and analytical methodologies</i>	<i>116</i>
5.2.2.3	<i>Systematic protocol related to the diagnostic and analytical strategies for Heraklion – Archaeological site of Knossos</i>	<i>117</i>
6	Conclusions.....	118
7	Selected sources and documents	120





1 Executive Summary

Deliverable D3.1 “Definition of a systematic protocol related to the diagnostic and analytical strategies for each different monument to be studied on the basis of the different structures, materials and weathering states” refers to the systematic approach of the HERACLES project dealing with the guidelines/procedures for the monitoring, diagnosis and analysis of the monuments/assets on the basis of their structural issues, materials and weathering states.

The protocols outlined in this document have been developed for the particular requirements and challenges of the HERACLES test-beds (Town Walls and Consoli Palace in Gubbio and Knossos Palace and Koules sea-fortress in Heraklion). Anyway, it is worth noting that these protocols can be tailored for other monuments/assets facing similar problems. Therefore, they are expected to act as preliminary operative guide for the diagnostic and analytical strategies in the Cultural Heritage maintenance and preservation field.

The aim of this document is to define a protocol for each monument/asset of interest in HERACLES on the basis of its structural and material preservation state.

The first part of this deliverable describes the sensing systems (from the satellite and wide area surveillance up to the in-situ sensors) and several laboratory material characterization methodologies and techniques, which are expected to give relevant information for defining and assessing the weathering state and the degradation processes of the investigated materials. The short description given for the sensors and methodologies provides useful information also for the possible generalization and “exportability” of the HERACLES sensing and analytical approach.

The defined protocols will be verified, during the subsequent activities of the project (especially the demonstration phases in WP8), with the aim to assess their efficiency and effectiveness. Therefore, it is expected that they will be eventually adapted, refined and generalized according to the outcomes of the testing phase for the project follow up.

The document is organized in separate Sections outlined in the following Introduction (Section 2).





2 Introduction

2.1 Document organization

The present document D3.1 is organized in Sections as follows:

- Section 2 includes the description of the document organization, the scope and the objectives, the relations with other Deliverables and the acronyms and abbreviations
- Section 3 briefly outlines the HERACLES test-beds, already described in detail in D1.2.
- Section 4 provides synthetic information about the available analytical and sensing techniques and is divided in four sub-sections:
 - Satellite/wide area sensing
 - Airborne/local area sensing
 - In-situ sensing using portable instruments
 - Ex-situ material analysis and characterization using laboratory facilities.
- Section 5 develops and suggests the systematic protocols for each test-bed with emphasis to their structural issues and material weathering state
- Section 6 summarizes the overall document.
- Section 7 lists the documents and sources used for D3.1.

2.2 Reference Documents

Document name	Reference number
HERACLES – Annex 1: Description of Work	Grant Agreement nr. 700395
HERACLES- Survey on guidelines and procedures for CH management	Deliverable D1.1
HERACLES - Definition of the end-users requirements with emphasis on HERACLES test-beds	Deliverable D1.2_Milestone MS1
HERACLES - Definition of methodologies for climate change impact evaluation and risk and vulnerability analysis	Deliverable D1.3
Selected sources and documents of the present document	Section 7 of the present document



2.3 Acronyms and Abbreviations

ACRONYM	FULL NAME
2D	Bi-dimensional
3D	Three-dimensional
3DR	Three-Dimensional Reconstruction (shape)
4D	Fourth-dimensional
AAT	Automatic Aero Triangulation
AFM	Atomic Force Microscopy
AIRS	Atmospheric Infrared Sounder on TERRA & AQUA
AMSU	Advanced Microwave Sounding Unit on TERRA & AQUA
AOT	Aerosol Optical Thickness
APM	Anthropogenic Pressure Modelling
ARPA	Agenzia Regionale per la Protezione Ambientale
ASCII	American Standard Code for Information Interchange
ASTM	American Society for Testing and Materials
ATR	Attenuated Total Reflectance
BF	Bright field
CC	Climate Change
CCEWM	Climate Change and Extreme Weather Modelling
CCD	Charge-Coupled device
CH	Cultural Heritage
CIR	Colour-InfraRed
CIRIAF	Centro Interuniversitario di Ricerca sull'Inquinamento da Agenti Fisici.
CNR	Consiglio Nazionale delle Ricerche
CNR- IREA	Consiglio Nazionale delle Ricerche, Istituto per il Rilevamento Elettromagnetico dell'Ambiente



CNR- ISMN	Consiglio Nazionale delle Ricerche – Istituto per lo Studio dei Materiali Nanostrutturati
COSMO-SkyMed	COntellation of small Satellites for Mediterranean basin Observation
CSV	Comma-separated values
CTE	Coefficient of Thermal Expansion
DAQ	Data acquisition
DEM	Digital Elevation Model
DF	Dark-field
DInSAR	Differential SAR Interferometry technology
DMA	Dynamic Mechanical Analyser
DRMS	Drilling Resistance Measuring System
DSC	Differential Scanning Calorimetry
DSC-TGA	Differential Scanning Calorimetry-Thermogravimetric Analysis
DSM	Digital Surface Model
DTM	Digital Terrain Model
EBSD	Electron Backscatter Diffraction
ED	Energy-Dispersive
EDS	Energy-Dispersive X-ray Spectroscopy
EDXS	Energy Dispersive X-ray Spectroscopy
e-geos	electronics-Global Earth Observation Services
ENVISAT	Environmental Satellite
EO	Earth Observations
EPS	Payload monitoring System
ERT	Electric Resistivity Tomography
ERS-2	European Remote Sensing satellite



FIB-SEM	Focused Ion Beam- Scanning Electron Microscopy
FORTH-IACM	Foundation for Research and Technology - Hellas , Institute of Applied and Computational Mathematics
FORTH-IESL	Foundation for Research and Technology - Hellas , Institute of Electronic Structure and Laser
FTIR	Fourier Transform Infrared Spectroscopy
ftp	File Transfer Protocol
geotiff	public domain metadata standard which allows geo-referencing information to be embedded within a TIFF (Tagged Image File Format) file
GIS	gas injection system
GIS	Geographic Information System
GM	Geomorphological Modelling
GNSS	Global Navigation Satellite Systems
GOME	Global Ozone Monitoring Experiment
GPR	Ground Penetrating Radar
GS	Ground Stability
GSD	Ground Sample Distance
HA	Hazard Assessment
HDF	Hierarchical Data Format
HR	High Resolution
HSB	Humidity Sounder for Brazil on TERRA & AQUA
IC/DIC	Interference Contrast/ Differential Interference Contrast
InSAR	SAR Interferometry technology
INSTM	The Consortium for Science and Technology of Materials (Consorzio Interuniversitario Nazionale per la Scienza e Tecnologia dei Materiali)
IPCC	Intergovernmental panel for Climate Change
ISS	Integrated Sensor Suite
LED	Light Emitting Diode





LIBS	Laser Induced Breakdown Spectroscopy
LIFS	Laser Induced Fluorescence Spectroscopy
LOD1	Level Of Detail 1
LOD2	Level Of Detail 2
LOS	Line of Sight
LST	Land Surface Temperature
LSM	Laser Scanning Microscopy /microscope
LVDT	Linear Variable Differential Transformer
MCM	Micro Climate Monitoring
MDC	Material Diagnostic and Characterization
MISR	Multi-angle Imaging Spectro-Radiometer
MODIS	Moderate Resolution Imaging Spectro-Radiometer
MPEF	Multi Photon Excitation Fluorescence
MS	Multi Spectral sensor
MSG	Meteosat Second Generation satellites
MSI	Multispectral Imaging
MWT	MicroWave Tomography
NetCDF	Network Common Data Form
NI	National Instrument
OMI	Ozone Monitoring Instrument
OPT	Optical sensor
PDMS	PolyDiMethylSiloxane
PL	Polarized Light
PM	Particle pollution, also called particulate matter
PS	Persistent Scatterer
PSI	Persistent Scatterer Interferometry





PSP	Persistent Scatterers Pairs
PXIe	Rugged PC-based platform for measurement and automation system
RAM	Random Access Memory
RASCAN/4000	Holographic radar system
RBR duet	Commercial temperature and depth logger- recorder
Res2DInv	Commercial software
RGB	Red, Green and Blue (colour code)
RH	Relative Humidity
RPAS	Remotely Piloted Aerial System
RTK	Real time positioning
SAM	Structural Analysis and Modelling
SAR	Synthetic Aperture Radar
SCIAMACHY	SCanning Imaging Absorption SpectroMeter for Atmospheric CHartographY
SD	Secure Digital
SEM	Scanning Electron Microscope
SERS	Surface Enhanced Raman Spectroscopy
SEVIRI	Spinning Enhanced Visible and Infrared Imager
SHD	Salt hydration distress
SFI	Solid Fat Index
SGM	Semi-Global Matching
SHG	Second Harmonic Generation
SHM	Structural Health Monitoring
SONREB	SONic REBound
SS-EN-ISO	Site Security- comité Européen de Normalisation -International Organization for Standardization
SVD (TSVD)	Singular Value Decomposition (Truncated Singular Value Decomposition)





TG- DTA	Thermogravimetry and Differential Thermal Analysis
THG	Third Harmonic Generation
TMS	Tomographic SAR
TSVD	Truncated Singular Value Decomposition
UAV	Unmanned Aerial Vehicle
UNINOVA	Universidade NOVA de Lisboa
UniPg/ UNIPG	University of Perugia
UoC/ UOC	University of Crete
UV-Vis-NIR	UltraViolet–Visible-Near-Infrared
UVB	Ultra-Violet-B
VHR	Very High Resolution
VNIR	Visible - Near Infrared
VOC	Volatile Organic Compound
VU	Vulnerability
WD	Wavelength-dispersive
WDXRF	Wavelength-dispersive XRF
WGS84	World Geodetic System 1984
WP	Work Package
XPS	X-Ray Photoelectron Spectroscopy
XRD	X-Ray Diffraction
XRF	X-Ray Fluorescence

2.4 Scope & Objectives

The HERACLES diagnostics and analytical strategy includes several heterogeneous sensors and diagnostic instruments, most of them complementary from the point of view of the type of acquired information, operating at different spatial and temporal scales and tailored to the monitoring of materials degradation, weathering state and structural parameters.





Starting from D1.2, where a description of different risks and related impacts on the sites has been presented, and from D1.3, in which a definition of the analysis of the climate change risks and vulnerability has been provided, the present document aims at defining a protocol for the analysis and diagnostics of the CH assets characterized by different structures, materials and weathering states.

The tools accomplishing this target are gathered in two very broad classes:

- the first class includes the sensors acquiring information on physico-chemical and structural parameters from a wide area to a local scale,
- the second class includes specific techniques and methodologies for the structural investigation and materials assessment.

With respect to D3.2, which is more focused on the development of an in-situ diagnostic protocol for quick assessment and monitoring of the weathering state in the areas of interest, this deliverable addresses the description of all the sensing tools, techniques and methodologies for a complete site health analysis, including the structural investigation and materials characterization at a general and comprehensive level.

2.5 Relation with other Deliverables

D1.1 (CNR): Survey of Procedures for the CH management, Report – M6

D1.2 (CNR): Definition of the end-users requirements with emphasis on HERACLES test-beds, Report – M9

D1.3 (FORTH): Definition of methodologies for climate change impact evaluation and risk and vulnerability analysis, Report – M9

D2.1 (e-geos): Geomorphological and structural modelling and monitoring, Report-M14

D2.2 (SISTEMA): Climate change, extreme weather conditions and anthropic pressure modelling, Report-M18

D2.3 (e-geos): Approaches for correlation/integration of the sensing technologies, Report-M18

D3.2 (FORTH): Development of an in-situ diagnostic protocol for quick assessment and monitoring of the weathering state and its progress on the areas of interest for the studied test-beds, Report – M12

D3.3 (e-geos): Intermediate analysis of the experimental and theoretical aspects underlying the state-of-the-art application of the satellite and airborne sensing technologies, Report- M13

D3.4 (CNR): Intermediate analysis of the experimental and theoretical aspects underlying the state-of-the-art application of in-situ sensing technologies, Report- M13





3 TEST-BEDS - A brief summary

The sites selected as test-beds for HERACLES project, including their requirements, have been thoroughly described in D1.2 “Definition of the end-user requirements with emphasis on HERACLES test-beds”. Nevertheless, a very brief summary is also given here for document consistency reasons. HERACLES test-beds represent a good example of the CH monuments/sites/assets within the European landscape:

- **Gubbio is an important historical monumental town in Central Italy, typical of the European landscape and can be considered the paradigm of the worldwide historical towns due to its well preserved status and its lively social life.** The old town of Gubbio is positioned on the slope of the Apennines hillside, dominating the town from the Northeast side and representing a critical point for hydrogeological risks for the monumental part of the town constituted by the “Città Alta” and represented in HERACLES by the Consoli Palace and the Town Walls. In addition, the old Town of Gubbio is affected by some important issues related to the building materials. These materials suffer from increased deterioration due to climate change effects coupled with pollution. They present also damaged parts which can lead to structural instability.
- **Knossos Palace is the largest Bronze Age site in Crete and is also considered the Europe's oldest citadel.** Knossos site is subjected to extreme weather events deriving from climate change and as a result, it faces significant weathering phenomena with emphasis to the erosion of selenite, a unique and particularly fragile material that characterizes this exceptional monument.
- **Rocca a Mare (Koules), the Venetian sea fortress of Heraklion.** Koules fortress, represents **all the typical coastal monument in the European territory**, which undergoes significant impact from the sea (storms and increased sea waves) directly connected to the risk of hazards from the climatic change.

Figure 1 shows the effects of characteristic extreme weather events, directly connected to climatic changes, on the HERACLES test-beds: (left-side) Gubbio, (centre) Knossos Palace and (right-side) Koules sea fortress.



Figure 1: Photos showing the effects of extreme weather events, directly connected to climatic changes, on the HERACLES test-beds: (left) May 2016, hail-storm in Piazza 40 Martiri in Gubbio; (center) January 2017, snow accumulation due to intense snowfall in Knossos Palace and (right) wave impact on Koules during winter time.



4 METHODS-SENSORS

This section regards the description of all the sensors and techniques. These comprise:

- satellite remote sensing, including optical, multispectral and radar (SAR) for wide area surveillance (Section 4.1);
- optical/VNIR instruments from airborne and remotely piloted aerial systems for local area sensing (Section 4.2);
- in-situ sensing technology including radar technology (ground penetrating radar, holographic radar), electromagnetic methods (ERT), for sub-surface investigation, punctual/micro-local sensors, namely, structural monitoring sensors (accelerometers, LVDT and related environmental parameter sensors), meteorological stations and oceanographic sensors (Section 4.3);
- Material Characterization Methodologies (Section 4.4)

4.1 Satellite/Wide Area Sensing

Wide area sensing with satellite instruments is carried on in HERACLES by means of: high and very-high resolution optical and visible-to-near infrared sensors for mapping and cartography; low resolution multispectral sensors for the measurement of parameters mainly useful for climate change and air pollution modelling; synthetic aperture radar for ground displacement measurements useful for structural health investigation.

4.1.1 Optical/VNIR Sensors

Table 1 schematically provides the details of the optical and Visible-to-Near Infrared (VNIR) satellite sensors addressed in this sub-section

Sensor	Reference Partner	Aim	Resolution
Space-borne optical/VNIR	e-geos	mapping and cartography	30-60 cm

Table 1: Details of the optical/VNIR satellite sensors

Rapid changes in the ground and anthropic activities require the acquisition of information in the shortest time and in the cheapest way; for this reason the studies about the potentialities of satellite imagery developed very fast in the last years.

Thanks to the second generation satellites, it is now possible to acquire imagery with geometric and semantic reliability, suitable for realization and updating of technical map on medium scale (1:25000-1:10000) and possibly on larger scale (1:5000).

A. Description of the sensor/sensors.

Optical/VNIR sensors, mounted on satellite platform, record the intensity of the reflected electromagnetic energy coming from the Sun or emitted by the Earth. Photo cameras, scanners, thermal cameras and video cameras are considered “passive” sensors.

Optical spectral range in the interval 0.3–15 μ m, typical of passive remote sensing, is identified by the sensors:

- pan-chromatic: one band including the visible range and in some cases part of the near infrared;
- multi-spectral: 2–9 spectral bands;
- super-spectral: 10–16 spectral bands;





– hyper-spectral: more than 16 spectral bands;

The increase of the number of bands typically improves the spectral sampling. Spatial resolution under or around 1 m (GSD, i.e., Ground Sample Distance) is referred as Very High Resolution (VHR) imagery.

Very high resolution optical sensors offer several advantages compared to the traditional photogrammetric techniques. They allow an easier acquisition of the same area at regular intervals, which is useful to monitor natural or technological phenomena evolving in time (e.g. urban area growth, natural disasters); moreover, it allows to obtain images of areas where it may be difficult to carry on photogrammetric flights (e.g. developing countries).

However, the real possibility of using high resolution images for cartography depends on several factors: sensor characteristics (geometric and radiometric resolution), types of products commercialized by the companies managing the satellites, cost and time to obtain these products and cost of commercial software for processing such products.

B. Measured parameter or information, spatial/temporal resolution

Optical sensors with high resolution on operational satellites provide a powerful tool to complement field investigations and to produce accurate and updated maps, mainly thematic but also topographic. These data have different spatial and spectral features that are summarized in the Table 2 below:

Platform Sensor Country Year Height (km) / Inclination (°)	GSD(m)/Nb of CCDs	MB/GSD (m)	FOV (°) /Swath (km)	Field of regard (°)	Revisit time (days)	Stereo B/H	Nb. of bits
EROS B PIC-2/TDI Israel 04/2006 -500/97.4	0.7/20,000	None	0.8/14	45 (360°)	1-3	Agile Variable	10
Kompsat-2 MSC Korea 07/2006 685/98.13	1/15,000	4/4	1.3/15	30 along 56 across	2	Agile Variable	10
Cartosat-2 PAN India 01/2007 635/97.92	0.8/12,000	None	0.59/9.6	45 (360°)	1-4	Agile Variable	10
WorldView-1 PAN/TDI USA 09/2007 496/97.2	0.5/35,000	4/2,44	2.12/17.6	0	2_6	Agile Variable	11
CBERS-2B HRC China-Brazil 11/2007 778/98.5	2.5/10,368	None	2.1/27	0	5	Agile Variable	8
GeoEye-1 USA 09/2008 681/98	0.41/31,000	4/1.65	1.28/15.2	0	1_3	Agile Variable	11
WorldView-2 USA 09/2008 770/97.2	0.46/30,000	8/1.85	1.28/16.4	0	1_4	Agile Variable	11
Pleiades 1A France 12/2011 694/98.2	0.70/35,000	2.8/4	/20	0	1	Agile Variable	16
Pleiades 1B France 12/2012 694/98.2	0.70/35,000	2.8/4	/20	0	1	Agile Variable	16
WorldView-3 USA 08/2014 617	0.31	8/1,24-8 SWIR/3,7-12 CAVIS/30	/13,1	0	4.5	Agile Variable	16

Table 2: Summary of the characteristics of VHR space-borne optical sensors generally used for 2D and 3D mapping

The trend toward finer spatial resolution is demanded by some specific applications as analysis of urban-related issues. Generally, most high-resolution images are characterized by a high spatial resolution and a low-spectral resolution that comprises only four bands:

- blue,
- green,
- red,
- near-infrared.





The fact that these systems can carry on stereoscopic acquisition reduces the gap between them and the classic aerial photogrammetry, although the latter is, generally, still currently preferred for the higher resolution that allows more rigorous cartographic use in digital mapping.

Once orientation problems are solved, the use of satellite images can be devoted to (like in classic photogrammetry):

- production of ortho-photos (geometrically corrected and georeferenced images);
- realization of stereoscopic model correctly oriented for restitution processes;
- map planimetric updating, exploiting the orthophotos derived from high resolution images

C. Description of the processing for output generation

To obtain an orthophoto-map with appropriate precision it is necessary to elaborate the image, choosing an orthorectific model suitable to eliminate the image distortions in order to obtain an image with metric features compatible with the cartographic applications. The distortions sources can be related to different causes: the acquisition system, which includes the orientation and movement of the platform; the optical-geometric characteristics of the sensor and of the observed object, which takes into account also atmosphere refraction, Earth curvature and terrain morphology. The image distortions have to be corrected by orientation and orthorectification procedures.

D. Spatial, temporal coverage and resolution on the HERACLES test-beds

An example of image correctly oriented and ortho-corrected, i.e. following the processing for correction of the distortions, is shown in Figure 2. In this case the CIR band combination has been used to emphasize the vegetation.



Figure 2: Digital ortho-corrected image in CIR band combination (Colour InfraRed)

Satellite optical surveys will be performed on demand at specific areas of the HERACLES test sites. These areas will be chosen during the planning of the measurement campaigns according to the needs/requirements of the involved end-users.



E. Typology of data accessibility

Very High resolution imagery have commercial access policy and they are licensed to the final end-user (e-geos in this project). VHR imagery are available from 1999-2002 (Ikonos I; QuickBird II) with a global multi-temporal coverage.

F. Output and relation to models

Thematic map and geospatial layers output of the described satellite acquisition are related to “Geomorphological model” and “Anthropogenic pressure modelling”.



4.1.2 Multispectral Sensors

The following Table 3 lists the satellite multispectral sensors used in HERACLES to measure climatic and pollution parameters that are described in this sub-section.

Table 3: list of the multispectral sensors with the reference Partners and measured quantities.

Sensor	Reference Partner	Measured parameter
Space-borne optical/VNIR	e-geos	mapping and cartography
MODIS	SISTEMA	Land Surface Temperature (LST)
AIRS/AMSU (AQUA)	SISTEMA	Relative Humidity (RH)
MODIS	SISTEMA	Aerosol Optical Thickness (AOT)
MISR (TERRA)	SISTEMA	Aerosol Optical Thickness (AOT)
GOME / ERS-2	SISTEMA	Nitrogen Dioxide NO ₂
GOME / ERS-2	SISTEMA	Ground-level Ozone O ₃
GOME / ERS-2	SISTEMA	Sulfure Dioxide SO ₂
OMI/Aura	SISTEMA	Nitrogen Dioxide NO ₂
OMI/Aura	SISTEMA	Ground-level Ozone O ₃
OMI/Aura	SISTEMA	Sulfure Dioxide SO ₂
SCIAMACHY / ENVISAT	SISTEMA	Ground-level Ozone O ₃
SCIAMACHY / ENVISAT	SISTEMA	Nitrogen Dioxide SO ₂

A. Description of the sensor/sensors

MODIS, MISR & AIRS/AMSU/HSB (TERRA & AQUA):

The Moderate Resolution Imaging Spectroradiometer (MODIS) delivers crucial information regarding Earth's environment. It is one of the instruments aboard both TERRA and AQUA satellites observing the Earth's surface and atmosphere. MODIS covers the entire Earth's surface every 1 to 2 days, acquiring data in 36 spectral bands, measuring visible and infrared radiation. Depending on the bands, the nominal spatial resolution ranges from 250 m (bands 1 to 2) to 500 m (bands 3 to 7) and 1000 m (bands 8 to 36). MODIS products used for HERACLES are Land Surface Temperature (LST), to generate e.g. temperature maps and Aerosol Optical Thickness (AOT) for the identification of the air pollution concentrations. Concerning the HERACLES project, the data collected by the sensors will be used as an input for the computation of relative humidity maps and, hence, as an input for the computation of erosion parameters.





GOME (ERS-2):

GOME, the Global Ozone Monitoring Experiment, launched on board of the second European Remote Sensing satellite ERS-2 in April 1995, was an UV/VIS spectrometer covering the spectral regions from 240 nm to 790 nm at a (spectral) resolution of 0.2 nm to 0.4 nm, primarily for the monitoring of the atmospheric ozone. From 1996 until 2011, GOME delivered global observations of total ozone O₃, nitrogen dioxide NO₂, other atmospheric trace-gases and aerosol distribution. GOMEs nominal spatial resolution is 40 x 320 km: the acquisition mode with the largest footprint (960 km x 40 km) provides global coverage at the equator within 3 days. GOMEs measurements of O₃, NO₂ and SO₂ concentrations will be used in HERACLES for the identification of degradation factors, based on historical data.

OMI (Aura satellite):

Aura objective is to study the chemistry and dynamics of Earth's atmosphere. Its key instrument aboard is OMI, the Ozone Monitoring Instrument, which monitors ozone O₃ and other trace gases such as nitrogen dioxide NO₂ and Sulphur dioxide SO₂. The OMI instrument is a nadir-viewing UV/VIS spectrometer which measures the solar radiation backscattered by the Earth's atmosphere and surface over a wavelength (spectral) range from 270 nm to 500 nm, with a spectral resolution of about 0.5 nm. The nominal spatial resolution is 13 x 25 km; a large swath allows daily global coverage. The concentration measurements of trace gases performed by OMI will help to identify degradation factors relevant for the HERACLES test sites.

SCIAMACHY (ENVISAT):

SCIAMACHY (SCanning Imaging Absorption SpectroMeter for Atmospheric CHartography), was an instrument on board of the Environmental Satellite (ENVISAT), which was operational from March 2002 to April 2012. It was designed to measure trace gases in the troposphere and stratosphere in the UV/VIS and NIR wavelength regions with a spectral resolution of 0.2 nm to 1.5 nm. The high spectral resolution and wide wavelength range made it possible to detect a variety of trace gases, despite low concentrations. SCIAMACHYs measurements of trace gas concentrations will be useful in the HERACLES project for the identification of degradation factors based on historical data.

SEVIRI (MSG):

SEVIRI, the Spinning Enhanced Visible and Infrared Imager aboard the Meteosat Second Generation (MSG) satellites, records data from an altitude of 35.800 km. The MSG satellites continually provide imagery of Earth every 15 minutes. SEVIRI, the main payload, has twelve spectral channels within the visible and infrared spectrum. Data recorded by SEVIRI are used in numerical weather forecasting models and in atmospheric and environmental research, so they will be helpful for the HERACLES project.

B. Measured parameter or information or phenomenon, spatial/temporal resolution

The following Table 4 summarises the details in terms of spatial resolution, time to achieve global coverage and orbit repeat cycle of the sensors used in HERACLES.





Table 4: Main characteristics of the sensors used in HERACLES

Sensor (Satellite)	Parameter	Spatial Resolution	Global Coverage	Repeat cycle
MODIS (TERRA & AQUA)	Land Surface Temperature (LST) [K]	1 km	1-2 days	16 days
	Aerosol Optical Thickness (AOT)	10 km	1-2 days	
AIRS/AMSU/HSB (AQUA)	Relative Humidity (RH) [%]	1 km	1-2 days	
MISR (TERRA)	Aerosol Optical Thickness (AOT)	275 m, 1.1 km	9 days	
GOME (ERS-2)	Nitrogen Dioxide (NO ₂) [molec/cm ²]	40 x 320 km	1 week	35 days
	Ground-level Ozone (O ₃) [DU]	5 km	1 week	
	Sulfur Dioxide (SO ₂) [DU]	40 x 320 km	1 week	
OMI (Aura)	Nitrogen Dioxide (NO ₂) [molec/cm ²]	13 x 25 km	daily	16 days
	Ground-level Ozone (O ₃) [DU]			
	Sulfur Dioxide (SO ₂) [DU]			
SCIAMACHY (ENVISAT)	Nitrogen Dioxide (NO ₂) [molec/cm ²]	60 x 30 km	3 days	35 days
	Ground-level Ozone (O ₃) [DU]			
	Sulfur Dioxide (SO ₂) [DU]			
SEVIRI (MSG)	Precipitation [mm]	1-3 km	daily	0.01 Days

C. Typology of data accessibility

The following Table 5 describes the data characteristics of the multispectral sensors in terms of accessibility, coverage and temporal interval.





Table 5: Multispectral data characteristics

Sensor (Satellite)	Data Accessibility	Coverage
MODIS (TERRA & AQUA)	open access	global; from 2000
AIRS/AMSU (AQUA)	open access	global; from 2002
MISR (TERRA)	open access	global; from 2000
GOME (ERS-2)	open access	global; 1995 – 2011
OMI (Aura)	open access	global; from 2004
SCIAMACHY (ENVISAT)	open access	global; 2002 – 2012
SEVIRI (MSG)	open access	global; from 2002



D. Short description of the processing for output generation

In the following Table 6 the processing, the archive typology and output characteristics of the multispectral sensors are summarized.

Table 6: Multispectral processing, archive and output characteristics of the sensors

Sensor (Satellite)	Processing
MODIS (TERRA & AQUA)	Ingestion of data; Data archive population in array database (rasdaman); Output generation in standard data format such as geoTIFF, netCDF for raster, xml, csv for time series
AIRS/AMSU (AQUA)	
MISR (TERRA)	
GOME (ERS-2)	
OMI (Aura)	
SCIAMACHY (ENVISAT)	
SEVIRI (MSG)	

E. Spatial, temporal coverage and resolution on the HERACLES test-beds

In the following Table 7 the details in terms of revisit time, spatial resolution and temporal interval of the multispectral sensor data available for the HERACLES test-beds are summarised

Table 7: Revisit time, spatial resolution and temporal interval of the multispectral sensor data over the HERACLES test-beds

Sensor (Satellite)	Revisit time	Spatial Resolution	Temporal Coverage
MODIS (TERRA & AQUA)	1-2 days	1 km; 10 km	from 2000
AIRS/AMSU (AQUA)	1-2 days	1 km	from 2002
MISR (TERRA)	2-9 days	275 m, 1.1 km	from 2000
GOME (ERS-2)	2-7 days	5 km; 40 x 320 km	1995 – 2011
OMI (Aura)	-	13 x 25 km	from 2004
SCIAMACHY (ENVISAT)	3-6 days	60 x 30 km	2002 – 2012
SEVIRI (MSG)	0.01 Days	1 km; 3 km	from 2002



F. Output

The following Table 8 lists the file formats and output products provided by the multispectral sensors.

Table 8: File formats and output products of the multispectral sensors.

Sensor (Satellite)	File Format	Output
MODIS (TERRA & AQUA)	Hierarchical Data Format (HDF)	Raster data (maps), ASCII data (time series) and statistical elaboration of both data formats (i.e. monthly mean, yearly mean, max value, min value etc.)
AIRS/AMSU (AQUA)	Hierarchical Data Format (HDF)	
MISR (TERRA)	Hierarchical Data Format (HDF) & Network Common Data Form (NetCDF)	
GOME (ERS-2)	Hierarchical Data Format (HDF)	
OMI (Aura)	Hierarchical Data Format (HDF)	
SCIAMACHY (ENVISAT)	Envisat data format (N1)	
SEVIRI (MSG)	Hierarchical Data Format (HDF)	

The output generated by the multispectral sensors can be visualized in the Meteo-Climate data platform as showed in the next Figure 3:

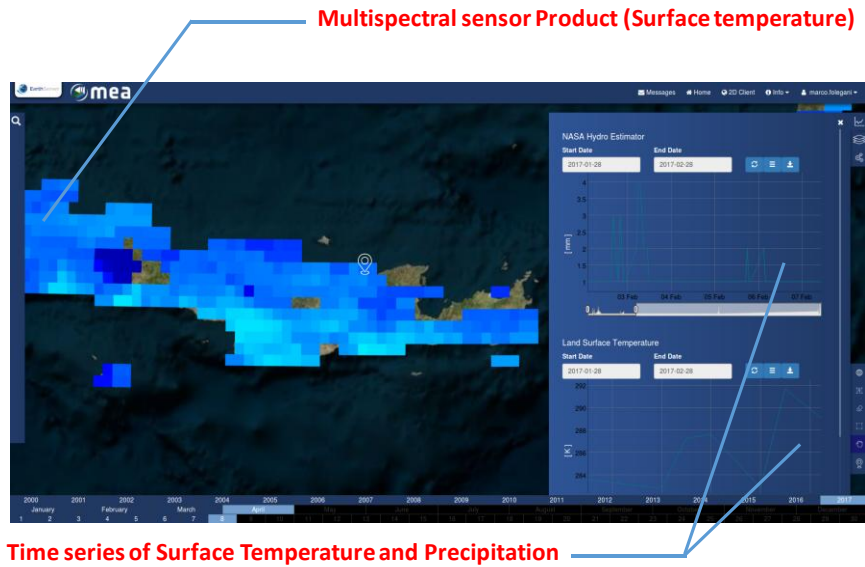

Figure 3: Meteo-Climate data platform with precipitation image product and time series of precipitation and surface temperature

The product selected and visualized by means of the Meteo-Climate data platform can be downloaded in geotiff and CSV data format for further analysis (Figure 4):

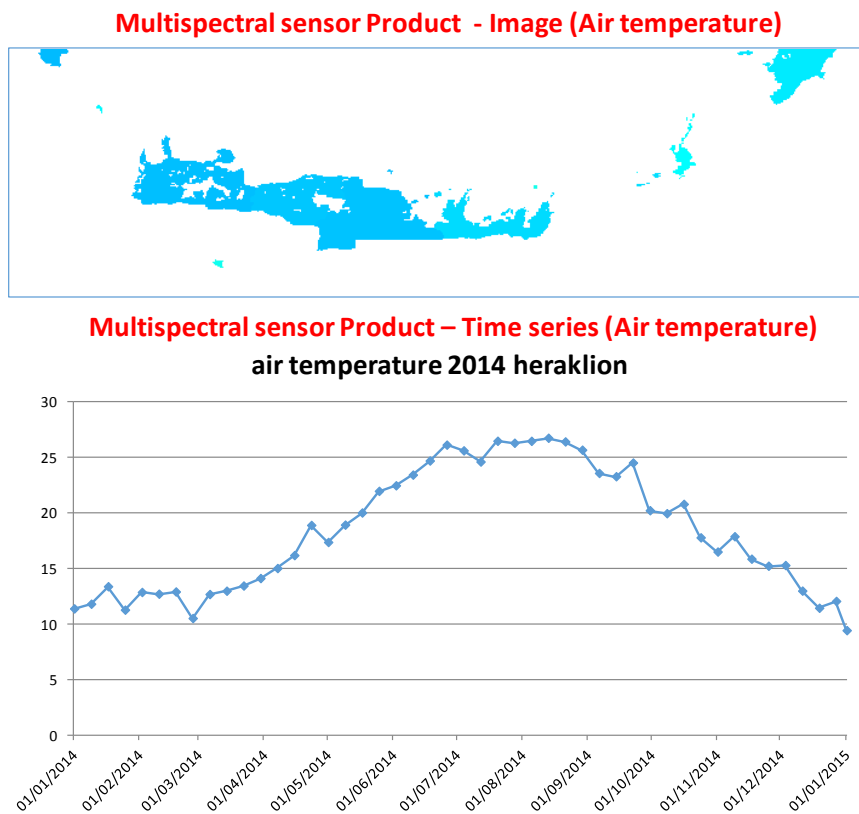

Figure 4: Downloaded image (colours are indicative of the spatial distribution of the temperature) and time series products of air temperature



4.1.3 Synthetic Aperture Radar Sensors

In the following Table 9 are listed the satellite imaging radar sensors (Synthetic Aperture Radar) used in HERACLES with the indication of the reference partner and the aim.

Table 9: SAR sensors, reference partner and aim

Sensor	Reference Partner	Aim
Space-borne radar COSMO-SKYMED	e-geos/CNR	regional site and single structure monitoring of deformation
Space-borne radar SENTINEL	e-geos	regional site and single structure monitoring of deformation

A. Sensors Description

Synthetic Aperture Radar (SAR) sensors are active radar systems operating in the microwave region of the electromagnetic spectrum. SAR is able to provide images characterised by resolutions comparable to optical images. Such systems are usually referred to as High Resolution (HR) or Very High Resolution (VHR) imaging radars.

The advantage of operating at microwaves are: a) sensors can be active and acquire useful data night and day; b) sensors can work in the presence of (almost) any atmospheric condition. As a result, compared to the optical sensors, SAR sensors allow systematic (i.e. regular) Earth’s observation capabilities.

A key peculiarity of SAR is the possibility to record both the amplitude and the phase information. The intensity is generally exploited for mapping of geology, land coverage, flooding detection, and wind estimation over the sea surface, etc. The phase can be further exploited for achieving 3D localization (topography mapping) in the so-called SAR Interferometry (InSAR) technology, as well as for the monitoring of natural hazards thanks to the Differential InSAR (DInSAR) techniques.

The rationale of InSAR and DInSAR, which are key technologies in HERACLES for the 3D reconstruction and the monitoring of CH assets, basically consists of analyzing the phase difference between SAR images of the same area acquired with different observation angles and at different epochs. Differences in the observation angle allow providing the 3D information; temporal diversity allows measuring the distance variations (“range” in the radar terminology) associated with slow, long term possible displacements of the *target*.

Modern DInSAR techniques, such as the Persistent Scatterer Interferometry (PSI) and SAR Tomography, use stacks of SAR images to monitor, with high accuracy, slow deformation phenomena and also to achieve accurate localization of the monitored points.

The availability of VHR data (up to 1 m resolution), acquired by new generation satellite systems such as Cosmo-SkyMed (used in HERACLES) and TerraSAR-X, have significantly improved the capability of SAR interferometric techniques in imaging and monitoring ground structures. DInSAR can allow a detailed monitoring of ground structures over wide areas, at low cost. Compared to traditional





ground monitoring techniques, but also to GPS, it allows going from a point-wise to a wide area perspective, preserving a high accuracy in the final results.

For interferometric use it is necessary that the SAR sensors acquire the data in “similar” viewing geometry. The orbits must be in fact repeated in a limited orbital tube. These requirements implies that the interferometric revisiting time of a scene varies typically from days to months, thus limiting the temporal sampling of the measurements. Accordingly, the use of the DInSAR technique in emergency situations requiring quasi real-time operation, is still limited.

Finally, it should be noted that DInSAR provides measurements that are the component of the ground 3D displacement along the Line of Sight (LOS). By using ascending and descending passes, where the sensor typically illuminate the scene with a LOS specular with respect to the vertical direction, it is possible to retrieve the vertical and (quasi) east-west components of the deformation. It is not possible to access the north-south deformation component. A more detailed description of the technology, with advantages and limitations, is demanded to Deliverable D3.3.

B. Measured parameter or information or phenomenon, spatial/temporal resolution

Displacements with millimeter accuracy are achieved by processing a stack of SAR data. Usually, the measurements are possible over sparse points (to be identified) corresponding to objects on the ground exhibiting radar backscattering properties which are stable over time. These points, called persistent scatterers (PS), are usually found in non-cultivated areas and with scarce vegetation.

Measured parameter Resolution/Sensitivity:

- PS positions: the measured positions (cartographic or geographic coordinates and heights, in meter) of the PS points with metric precision.
- PS deformation mean velocities: the measured PS points deformation mean velocities, in mm/year, during the period between the first and the last SAR acquisition dates with millimetric precision.
- PS displacement temporal evolutions: the measured PS displacement, in millimeters, at each acquisition date in the analyzed period with precision of a few millimeters.

Displacement of PS (Geo-referred in 3D) are measured in the radar LOS (approximately toward East for ascending passes, toward West for descending passes).

Spatial Resolution: 1-3m by 1-3m for Very High Resolution (VHR) systems like COSMO/SkyMED or 5m by 20m for High Resolution (HR) systems like Sentinel 1A and Sentinel 1B.

C. Typology of data accessibility

Sentinel (HR) data: open access, global coverage subject to the availability of useful interferometric dataset (repeated orbits), time availability from mid-2014

COSMO/SkyMED (VHR): commercial or free for scientific use (subject to approval), global coverage subjected to the availability of useful interferometric dataset (repeated orbits), time availability from mid-2007. In HERACLES they will be used with higher priority for the higher resolution properties.

D. Short description of the processing for output generation

In HERACLES two approach will be used: Persistent Scatterers Pairs (PSP) [1] by e-geos and SAR Tomography (TMS) by CNR-IREA [2]. Both chains provide geo-localized data and deformation measurements. SAR Tomography is specifically tuned to the imaging and monitoring of buildings. Just





as examples of results achieved by PSP and TMS area are shown in Figure 5 (not referred to HERACLES test-beds).

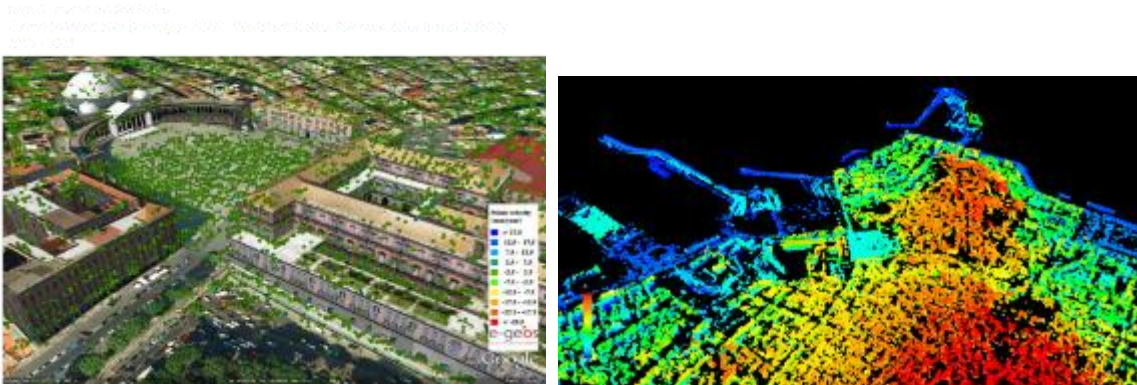

Figure 5: **Left:** example of PSP product (colourscale according to the mean deformation velocity); **right:** example of a TMS product (colourscale according to the topography with a variation of 80 m from blue to red)

E. Spatial, temporal coverage and resolution on the HERACLES test-beds

VHR data: COSMO-SKYMED on Crete (Greece)

Archives for COSMO-SkyMED data have been investigated to check the availability for the Crete test-beds. The temporal distribution of the acquisitions for the descending dataset is reported in the diagram in Figure 6: the horizontal axis shows the acquisition epoch whereas the vertical axis shows the temporal separation between two successive acquisitions. The diagram highlights that, although the overall temporal span is rather limited (almost 1 year), the temporal sampling is satisfactory with a maximum separation mostly below 20 days.

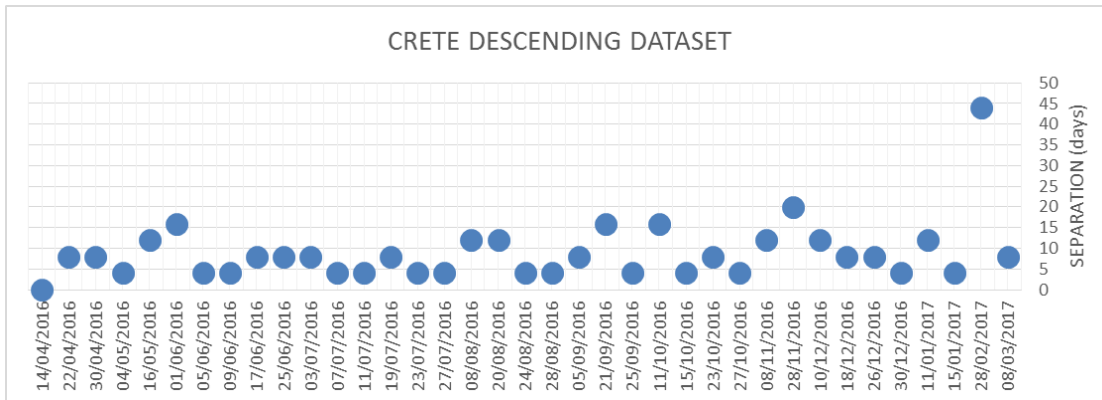

Figure 6: Temporal distribution of the Crete descending dataset

Figure 7 shows the distribution for the ascending dataset. From the analysis of the diagram it is evident that the temporal span is increased (more than 1 year), the temporal sampling shows gaps of more than 30 days, which can be still considered satisfactory.

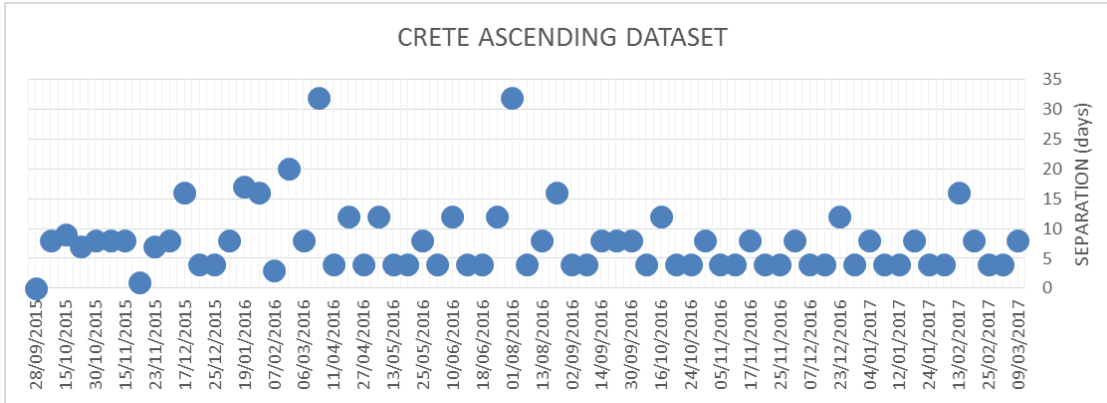

Figure 7: Temporal distribution of the Crete ascending dataset

VHR data: COSMO-SKYMED on Gubbio (Italy)

Archives for COSMO-SkyMED data have been investigated to check the availability also for Gubbio site. For this test bed, too, both ascending and descending datasets are available.

The temporal distribution of the acquisitions for the descending dataset is reported in Figure 8: the axes are according to the Crete case. The diagram shows that the time span is now long more than 5 years; however large temporal gaps are present at the end of 2014 and again at the beginning of 2015. The large temporal gaps, in conjunction with topographic variation, vegetation coverage and typical meteorological conditions of the test area, might pose a criticality in the data processing. If necessary, the remediation could consist in splitting the acquisition in two datasets before and after the gaps. They will undergo a separate processing, as well.

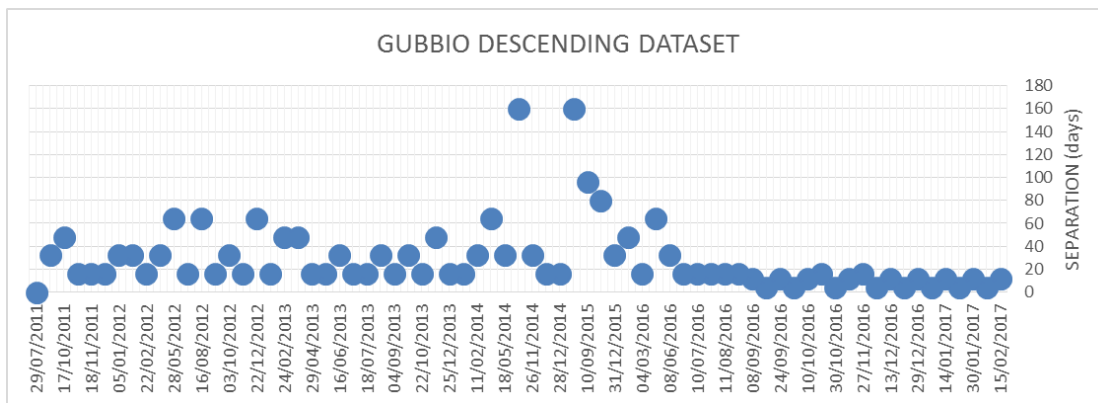

Figure 8: Temporal distribution of the Gubbio (Italy) descending dataset

Finally, in Figure 9 it is shown the distribution for the Gubbio ascending dataset. The diagram shows that large temporal gaps are mainly limited to the initial observation period. If necessary, the criticalities will be treated as described previously.



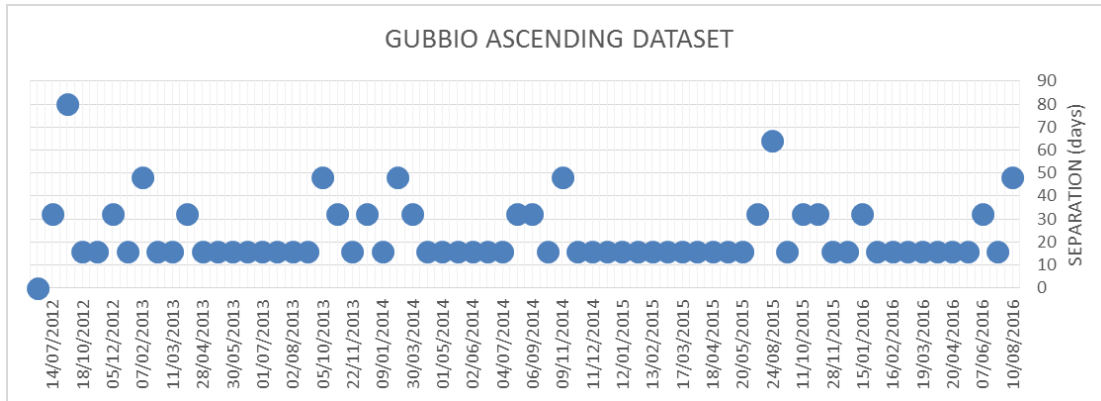

Figure 9: Temporal distribution of the Gubbio (Italy) ascending dataset

F. Output and relation to models

The standard output product of the interferometric processing is a sparse map of the detected PS characterized by ancillary information as localization parameters (geographic coordinates and heights with respect to the WGS84 ellipsoid), superficial deformation parameters (time series of the measured deformation at the SAR acquisition instants, deformation mean velocity in the observation period), quality index representing the temporal coherence of the PS and the directional cosines of the radar Line-of Sight (LOS). Output is formatted in txt files and shapefiles importable in common Geographical Information System (GIS). It can be used for 3D reconstruction, hazard and vulnerability assessment.



4.2 Airborne/Local area sensing

The following Table 10 schematically provides the details of the optical and Visible-to-Near Infrared airborne sensors addressed in the sub-section.

Table 10: HERACLES airborne sensors, reference partner and aim

Sensor	Reference Partner	Aim
Airborne optical/VNIR	e-geos	mapping and cartography

A. Description of the sensor/sensors.

Aerial photogrammetry

Recent advancements in digital photography, Global Navigation Satellite Systems (GNSS) and computer modelling software have made simpler and quicker the process of gaining quality data from an aerial survey. The applications are extensive for photogrammetry as it can be used to create maps and realistic 3D surface model. Digital aero photogrammetric cameras are evolving and already have a scientific and practical importance, thus providing methods to achieve quantitative information. The advantage of aircraft acquisitions derives from the large flexibility, adaptable to every specific need, especially the temporal one. However, airborne images are typically affected from more severe distortions compared to satellite images: this is mainly due to the instability of the acquisition platform. The scales of representation in photogrammetric acquisitions are generally comprised between 1:2000 and 1:25,000 with special applications at smaller and larger scales. The synoptic view is a function of the flight height, and the geometric resolution and flexibility of acquisition are better compared to the satellites observations.

RPAS photogrammetry

Unmanned Flight system technologies have seen exponential growth over the past decade, resulting in highly autonomous and accessible machines capable of a large range of functions. Unmanned Aerial Vehicle (UAV) or RPAS (Remotely Piloted Aerial System) platforms are nowadays a valuable source of data for inspection, surveillance, mapping and 3D modelling issues. As RPAS can be considered as a low cost alternative to the classical manned aerial photogrammetry, rotary or fixed wing RPAS, capable of performing the photogrammetric data acquisition, can fly in manual, semi-automated and autonomous way. Following a typical photogrammetric workflow, 3D results like Digital Surface or Terrain Models (DTM/DSM), contours, textured 3D models, and vector information, can be generated even on large areas. Real-time positioning using GNSS receivers mounted in bundle with an optical camera improves the positioning accuracy of the camera principal point and hence the overall accuracy of the geo-referenced model. Figure 10 provides a graphical description of the characteristics in terms of accuracy and coverage (area size) of different instruments.

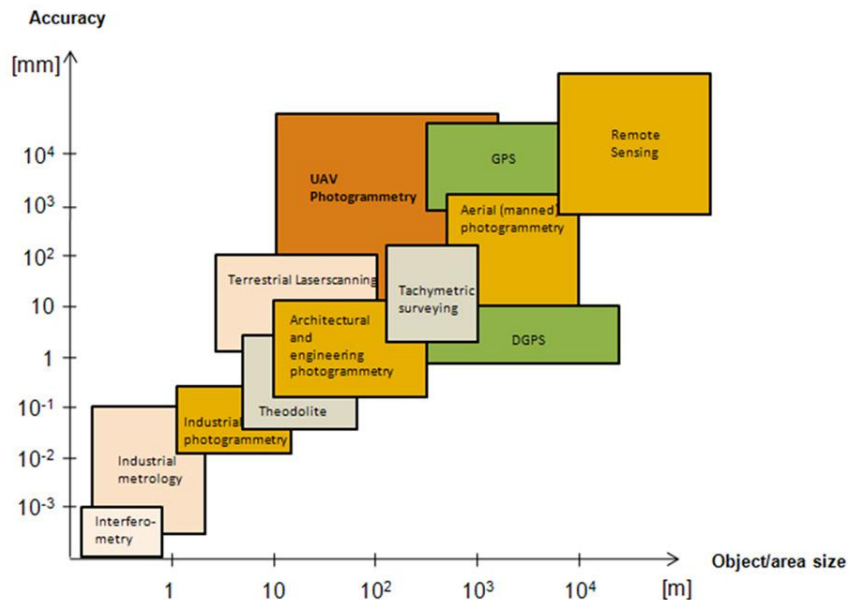

Figure 10: The graph shows the relationship between object area size and accuracy using UAV's compared to other forms of remote and close range survey [3].

B. Measured parameter or information, spatial resolution and sensed quantity

The scales of representation in photogrammetric acquisitions are generally ranging between 1:2000 and 1:25000 with special applications at smaller and larger scale. For RPAS photogrammetric collection, cartographic and 3D model nominal scale, is more than 1:1000 (up to 1:200).

The desired image scale and used camera focal length are generally fixed in order to derive the mission flying height. The camera perspective centres (“waypoints”) are computed by fixing the longitudinal and transversal overlap of the strips (e.g. 80%-60%). All these parameters vary according to the goal of the flight; missions for detailed 3D model generation usually request high overlaps and low altitude flights to achieve small GSDs.

C. Typology of data accessibility

In this project, the owner of the data is e-geos. Data will be accessible to all HERACLES partners for scientific purposes. Data accessibility to third parties or for commercial purposes will be decided in agreement with HERACLES Consortium.

D. Description of the processing for output generation

Digital Elevation Model generation

The DSM/DTM generation is based on photogrammetric approach with the support of the most recent techniques based on multi-view stereo and dense image matching algorithms.

The point cloud extraction method is relying on recent significant improvements in hardware and algorithms and requires less manual interaction.

The subsystem for DSM generation allows a digital accurate reconstruction of surfaces from calibrated and oriented images, and is based on an automated procedure for surfaces reconstruction from image data. Terrain dataset can be subsequently extracted, filtering the original point cloud surface, through the use of automatic algorithms (max local slope approach) and manual editing.





The implemented reconstruction pipeline is based on images with given orientation parameters and subsequently performs different processing steps:

1. Image orientation
2. epipolar image generation
3. dense multi-stereo matching
4. conversion from point cloud to DSM

The DEM generation flow is shown in the following scheme – Figure 11

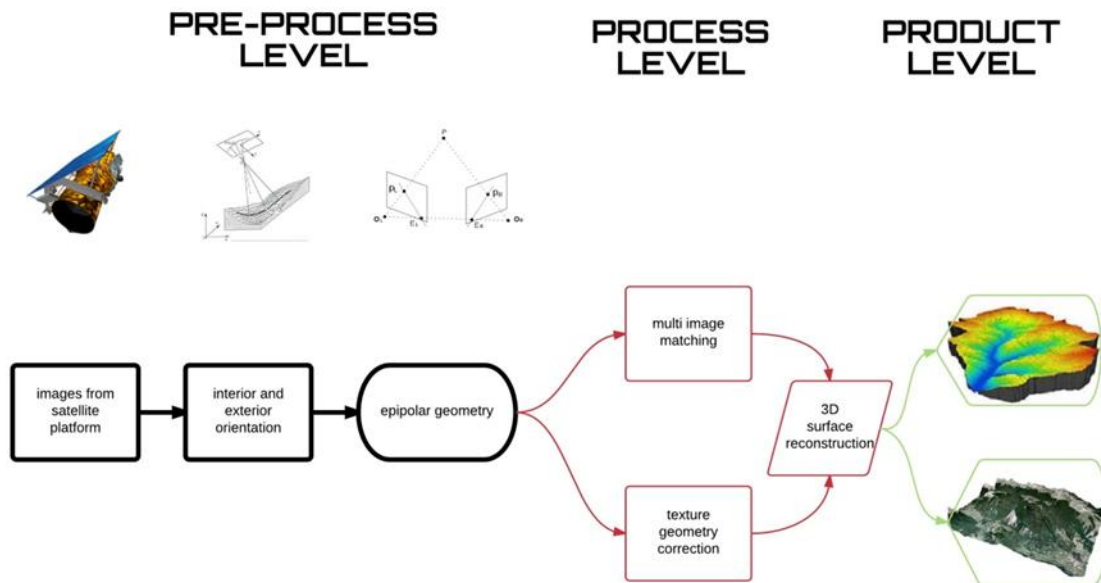

Figure 11: scheme from satellite to 3D surface reconstruction

E. Visual example of the sensor/technique output

The following figures (Figure 12, Figure 13, Figure 14) show typical examples of the above described sensors/technique outputs.



Figure 12: Aerial Orthophoto

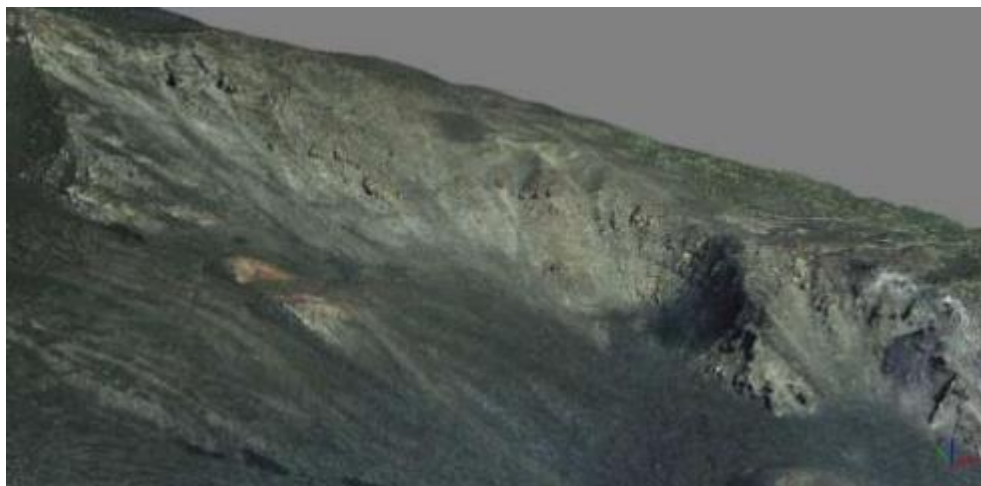

Figure 13: RGB point cloud representation of a volcanic surface

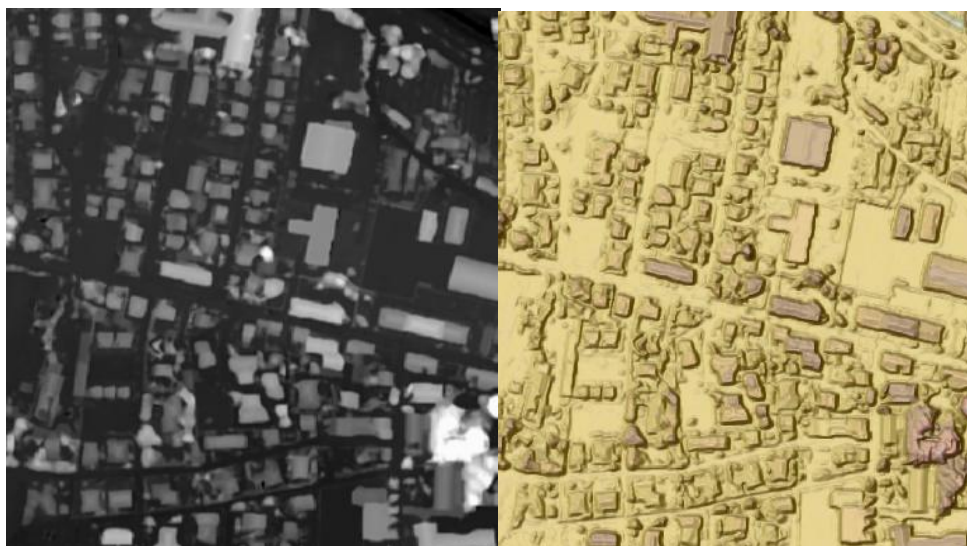

Figure 14: A raster representation of a 3D model (DSM)



F. Spatial, temporal coverage and resolution on the HERACLES test-beds

RPAS surveys will be performed at specific areas of the test sites of the HERACLES project. A first couple of data will be collected on the two monuments in Gubbio (400 meters of the Town Walls and the Consoli Palace); a second couple of data will be achieved in Heraklion over the described sites on the Knossos Palace and on the Koules Sea Fortress. Resolution will be chosen during the planning of the measurement campaigns according to the requirements of the involved end-user.

G. Output and relation to models

Products output of these surveys (3D models, orthophoto and geospatial layers) are related to Geomorphological model, Structural analysis and Climate change and extreme weather conditions modelling.



4.3 In-situ sensing

HERACLES monitoring involves a large variety of in-situ sensing technologies. With respect to satellite and aerial sensing, which provide the possibility to acquire surface information, in-situ sensors will allow investigating also the sub-surface, thus providing useful information for hazard and vulnerability analyses, as well as for structural health monitoring. Local structural monitoring sensors, also equipped with temperature recording and micro-local multi-parametric environmental monitoring, will be mainly used to provide important information for structural monitoring. Meteorological stations, useful for local meteorological monitoring and also for calibration of satellite measurements, will be included in the HERACLES facilities and are therefore described in this sub-section. Similarly, oceanographic sensors will provide information useful for coastal hydrodynamic monitoring (mainly waves) and modelling. A list of the sensors is presented in Table 11, together with the related reference partner and aim.

Table 11: In-situ sensors, reference partner, measured parameters and aims, related to their use in HERACLES

Sensor		Reference partner	Measured parameter & aim
GPR (D3.2)		CNR-IREA	Subsoil surveys and vertical structure inspections
Holographic Radar (D3.2)		CNR-IREA	Surface and sub-surface surveys
ERT (D3.2)		CNR-IREA	Electrical resistivity for water voids and fractures in the investigated subsoil
Structural monitoring sensors	Accelerometer	UNIPG	Single point dynamic measurement of acceleration (structural vibration) for structural analysis and monitoring purposes
	Linear Variable Displacement Transducer (LVDT)	UNIPG	Single point static measurement of crack amplitude for structural analysis and monitoring purposes
	Temperature	UNIPG	Single point measurement of surface or air temperature
	Payload monitoring System (EPS)	UNIPG	Hand light portable or payload collecting air temperature, surface temperature, relative humidity, CO, CO ₂ , VOC, PM10, PM5, solar radiation, wind direction and speed, illuminance level



Meteorological- Stations	FORTH-IACM	Fixed installation, 3m mast meteorological stations, to be installed one (1) on Koules and one (1) in Knossos for measuring Wind Speed and Direction, Temperature, Humidity, Rainfall, Solar Radiation and UV Index
Oceanographic sensors	FORTH-IACM	Fixed installation, wave gauges, to be in two positions in the sea area in front of Koules for measuring sea levels and sea Temperature.

4.3.1 GPR

A. Description of the sensor/sensors.

GPR is a well assessed electromagnetic technology, which is used to obtain images of the inner part of the investigated region. From these images information on structural hazards probably caused by important weathering phenomena or extreme natural events related to climate changes can be deduced.

The working principle is the same of the traditional radar one, i.e., a transmitting antenna radiating a probing wave into the investigated medium (a soil, a wall, a road and so on) and a single (standard GPR) or multiple receiving antennas (array GPR) are used to collect the field backscattered by the targets. More precisely, a time-domain standard GPR system transmits a modulated time domain pulse and collects the reflected energy as a function of time, which represents the travel-time of the wave along the transmitter-target-receiver path. By shifting the transmitting and receiving antennas along a line and joining together the gathered traces at all the antenna positions, a spatial-time image is built, which is referred to as raw-data “radargram” or B-scan. Being the round-trip travel time a function of the distance occurring between antennas and targets, the radargram provides a distorted image of the hidden objects, which appear as hyperbolas whose characteristic features (i.e., vertex and eccentricity) depend on the object position, shape, size and electromagnetic properties of the probed medium.

Accordingly, a GPR system, equipped with suitable data processing approaches, allows to generate high resolution images, which provides 2D and/or 3D representations of the sub-surface features of the structure under test. More specifically, it can be exploited as a non-invasive and cost effective tool to perform structural integrity assessment and quick damage valuation. At CNR-IREA, a time domain GPR radar system is available and will be used during the HERACLES project. The system is equipped with a dual frequency single fold shielded antenna working at the nominal central frequencies of 200 MHz and 600 MHz, which is suitable for sub-surface prospecting, and a single frequency and single fold shielded antennas with nominal central frequency of 2 GHz, which is used for vertical inspections.

In the frame of the HERACLES project, GPR technology will be used on demand for the following main purposes:

- imaging of reinforced structures, cavities and cracks, whose detection and characterization is useful to infer information about the maintenance status of structures;





- detection and localization of not directly observable defects, such as water infiltrations and material changes due to natural ageing process as well as by crisis events such as seismic, hydrogeological and extreme weather actions.

B. Sensed quantity, spatial/temporal resolution

Detection and localization of hidden objects such as material stratification, reinforced structures, cavities, cracks and not directly observable defects (i.e. water infiltrations and material changes). The achievable spatial resolution depends on the frequency of the probing waves and the electromagnetic features of the investigated medium.

C. Typology of data accessibility

The owner of the data is the entity possessing the GPR system (CNR-IREA in this project). Data will be accessible to all the HERACLES partners for scientific purposes. Data accessibility to third parties or for commercial purposes will be decided in agreement with the HERACLES Consortium.

D. Description of the processing for output generation

Since a radargram provides a distorted representation of the scenario under test, wherein the targets appear as hyperbolas, its interpretability may strongly depend on the user expertise and this limits the radar imaging usefulness, especially in complex environments. However, by processing the radargram, it is in principle possible to obtain images providing a complete characterization in terms of geometrical parameters (i.e., location, size and shape) and electromagnetic features (i.e., relative permittivity and dielectric conductivity) of hidden objects and/or material changes. Of course, this involves the use of sophisticated data processing approaches based on an accurate model of the electromagnetic scattering and capable of accurately solving the relevant non-linear inverse scattering problem.

Among the data processing strategies proposed in the GPR literature, a significant role is played by the MWT. In particular, it is considered an imaging approach based on an integral frequency domain integral formulation based on Born Approximation to describe the relationship between the scattered field (i.e. the data) and the electric unknown contrast function. This contrast function accounts for the target as an anomaly in terms of electromagnetic properties with respect to the ones of the background medium. The imaging is faced as the solution of a linear inverse scattering problem and a stable solution is obtained by using the Truncated Singular Value Decomposition (TSVD).

To give an idea of the potentialities offered by GPR surveys and the improvements in terms of imaging capabilities, which can be obtained by applying the MWT approach, in Figure 15 are shown the results of a measurement campaign carried out in the past on a reinforced concrete structure. Specifically, Figure 15a shows an example of the cross-section image provided by a GPR survey (before applying the MWT approach), which shows the reinforcement elements of the investigated structure. Figure 15b, instead, shows some slices at different constant depths, which visualize the reinforcement elements as reconstructed by processing the GPR data by means of the MWT

approach.

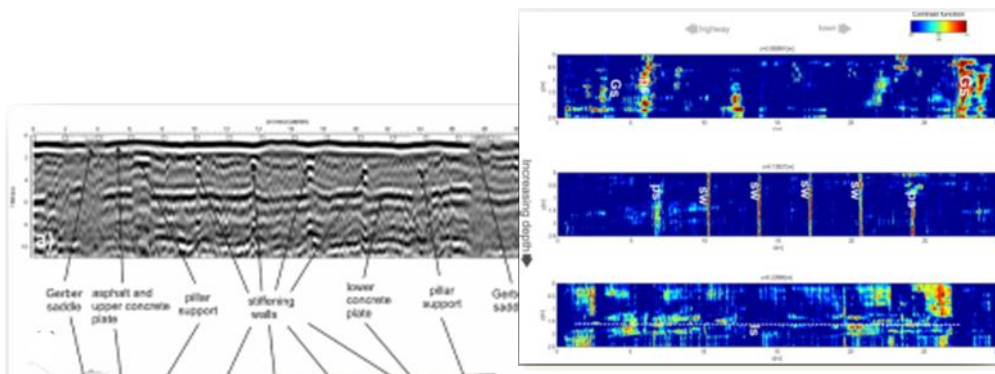

Figure 15: Example of a GPR image of the reinforcement elements of a structure (a); the related tomographic image at increasing constant depths (b).

E. Measurement characteristics on the test-beds

GPR surveys will be performed on demand at specific areas of the test sites of the HERACLES project. These areas will be chosen during the planning of the measurement campaigns, according with the requirements of the involved end-user. They will regard mostly ground areas for the Gubbio town Walls as well as floor and walls in Consoli Palace.

GPR surveys will provide a local snapshot of the investigated areas at the time of the survey, thus collecting information about their sub-surface/hidden features.

F. Output and relation to models

GPR raw data and processed ones are formatted in ASCII files and under the form of images. Output of GPR surveys can be used for structural analysis and health diagnosis and monitoring.

4.3.2 Holographic radar

A. Description of the sensor/sensors.

Among the other diagnostic tools, holographic radars are diagnostic tools capable of providing holograms of hidden objects by exploiting amplitude information about the interference arising between the backscattered field and the reference signal.

During the HERACLES project, the RASCAN-4/4000 holographic radar system, developed and commercialized by the Remote Sensing Laboratory at the Bauman Moscow Technical University and available at CNR-IREA, will be used.

The radar system RASCAN-4/4000 uses not modulated continuous wave signals and, at each probe position, records the amplitude of the interference signal arising between the backscattered field and a constant-phase reference field. The latter is given as the direct coupling between transmitting and receiving antennas. In particular, the system exploits three antennas, one transmitting and two receiving, which simultaneously collect the interference signals related to the parallel and orthogonal polarizations of the backscattered field. Moreover, to avoid the effect of destructive interferences, which would obscure objects located at some depths, RASCAN-4/4000 collects, for each spatial point,



the interference signals arising at five discrete frequencies belonging to the range [3.6–4.0] GHz and spaced of 100MHz. As a meaningful signal will be collected at least for one frequency and for one polarization, the capability of detecting hidden targets is improved.

B. Sensed quantity, spatial/temporal resolution

Differently from GPR systems, the holographic radar does not provide depth information about the detected sub-surface/hidden objects, but allows an accurate image of their geometrical features, i.e. shape and size. Moreover, despite a maximum sounding depth of about 20 cm can be reached in some favorable cases (this strongly depends on the electromagnetic features of the investigated medium), objects located in the first 10 cm below the scanning plane are usually detectable by RASCAN-4/4000. Finally, even if a theoretical analysis is not available, according to the adopted frequency range and based on the designers' expertise, a nominal resolution of 2–3 cm is expected in the plane of view, when low-loss materials are investigated.

C. Typology of data accessibility

The owner of the data is the entity performing the surveys by means of the holographic radar. Data will be accessible to all the HERACLES partners for scientific purposes. Data accessibility to third parties or for commercial purposes will be decided in agreement with the HERACLES Consortium.

D. Description of the processing for output generation

A tomographic imaging approach specifically tailored to process holographic data, will be adopted to improve the achievable spatial resolution. Such an approach exploits the Kirchhoff approximation to model the interactions among electromagnetic signals and materials/targets and casts the imaging as a linear inverse scattering problem, wherein the unknown is a function encoding the geometrical features of the targets. Moreover, due to the ill-posed nature of the problem to be solved, a regularization strategy is adopted in order to avoid instable solutions and error propagation. In particular, the truncated SVD (TSVD) is considered as an effective and efficient strategy capable of avoiding error amplification and, thus, achieving a stable solution.

In addition, strategies to combine data collected at different frequency and at the two polarizations will be designed and applied.

Figure 16 represents the outcome of the in-situ diagnosis carried out in the past by using the holographic radar. In particular, Figure 16a shows a picture of the two probed regions (which are denoted as region A and B and are located on the shell of the bridge), together with the radar equipment. The corresponding tomographic images are shown in Figure 16b. The top panel is referred to the region A and reveals the presence of two slanting rebars about 1.5 cm thick and 20 cm spaced one to each other. The bottom panel is instead referred to region B and reveals a complex hidden scenario where several anomalies occur into the shallower concrete layer.

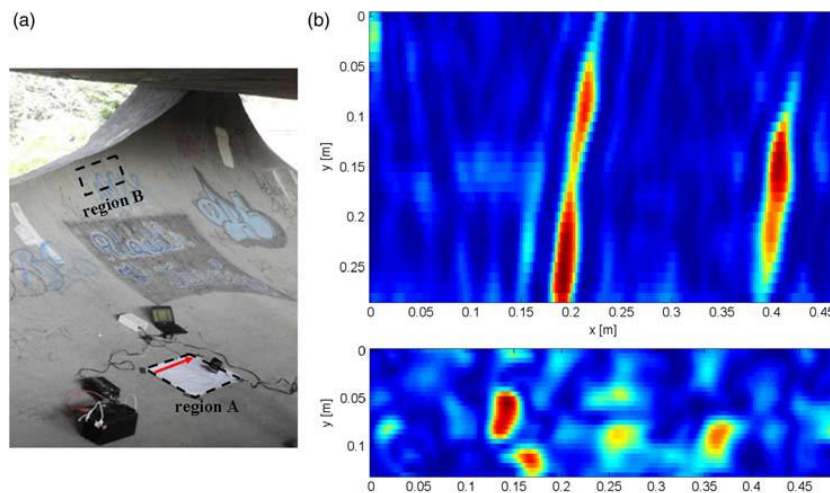

Figure 16: Example of past holographic radar results: scenario under test (a); image of the reinforcement element of a structure and the related tomographic image at increasing constant depths (b).

E. Spatial, temporal coverage and resolution on the HERACLES test-beds

Investigations by means of holographic radar will be performed on demand at specific areas of the Gubbio test site. These areas will be chosen during the planning of the measurement campaigns and will regards mainly portions of flat surfaces of the Consoli Palace. These analysis provide a local 2D image of the hidden detectable electromagnetic anomalies characterizing the investigated areas at the time of the survey.

F. Output and relation to models

Holographic raw data and processed ones are formatted in ASCII files and available also as images. These data can be used for structural analysis and health diagnosis and monitoring.

4.3.3 ERT

A. Description of the sensor/sensors.

The Electrical Resistivity Tomography (ERT) method is an in-situ electromagnetic sensing technique, which is useful to characterize sub-surface materials in terms of their electrical properties.

ERT can be considered as a powerful tool for detecting and imaging shallow sub-surface targets characterized by conductive properties that are very different from the ones of the host medium. Although most rock-forming minerals are electrical insulators, the resistivity in earth materials are primarily controlled by the movement of charged ions in pore fluids. In fact, ground water generally contains dissolved compounds that greatly enhance its ability to conduct electric currents. Hence, porosity and fluid saturation tend to dominate electrical resistivity measurements. Besides the pores, fractures within crystalline rock can lead to low resistivity values if they are filled with fluids. Accordingly, variations in electrical resistivity (or conductivity) may be used to map stratigraphic units, geological structure, sinkholes, fractures and groundwater. Accordingly, ERT is currently used applied in the study of a wide class of geological and environmental problems (i.e. structural studies, fault mapping, landslide surveying, polluted site monitoring, etc.).



B. Sensed quantity, spatial/temporal resolution

Resistivity of the ground is evaluated by injecting electrical currents in the medium and measuring the induced electric potential differences at the surface. Two pairs of electrodes are required: one pair is used for current injections, while the other one is adopted for potential difference measurements.

The result of an ERT survey is a spatial distribution 2D or 3D of apparent resistivity where each data point is defined by two coordinates (x and z) depending on the position of the quadrupole used (couple of current and potential dipoles) and a value of apparent resistivity. Then, in order to reconstruct real resistivity distribution, an inversion routine is required and a number of algorithms are available in order to perform this reconstruction.

The ERT exhibits significant potentialities in terms of high resolution and flexibility of the investigation depth that can be varied in a simple way, by varying the electrode spacing. Indeed, a large electrode spacing provides a high investigation depth and a low spatial resolution. On the contrary, a small electrode spacing allows to achieve a great spatial resolution but a low investigation depth. This feature makes the ERT a good candidate for the structure and infrastructure monitoring. Furthermore, change in the resistivity can be detected by comparing resistivity data taken at sequential times.

C. Typology of data accessibility

The owner of the data is the entity performing ERT measurement campaigns. Data will be accessible to all the HERACLES partners for scientific purposes. Data accessibility to third parties or for commercial purposes will be decided in agreement with the HERACLES Consortium.

D. Description of the processing for output generation

As previously reported, an inversion procedure is necessary to reconstruct real resistivity distribution from the apparent one. One of the successful routine performing this task is the Res2DInv commercial software, which is able to perform an automatic 2D inversion starting from the apparent resistivity data. Such an inversion approach is based on the smoothness constrained least-squares inversion implemented by a quasi-Newton optimization technique.

As an example concerning the use of ERT surveys for foundation soil inspection, Figure 17 shows the ERT profile obtained in the past by using Res2DInv software. Based on this figure it can be deduced the presence of a shallow layered structure formed by a low resistive landfill up to 0.3-0.4 m followed by a medium resistive layer up to 1.0-1.20 m and a high resistive bedrock showing a very strong resistive nucleus (R). Moreover, a fault can be deduced at 24 m about where an abrupt change in resistivity occurs.

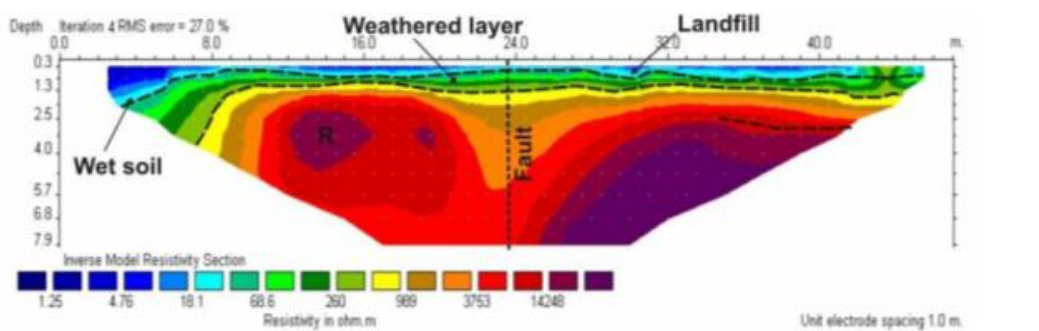

Figure 17: Example of ERT result in the framework of soil foundation survey.



E. Characteristics of the measurements on the test-beds

ERT surveys will be performed on demand at specific areas of Gubbio. These areas will be chosen during the planning of the measurement campaigns according with the requirements of the involved end-user and will regards mainly portions of the ground in the zone of the Gubbio ancient walls, which will have a coverage of few tens of meters.

ERT surveys will provide a local 2D or 3D snapshot of the investigated areas at the time of the survey, providing information about their sub-surface/hidden features.

F. Output and relation to models

ERT data are formatted in ASCII files and are available also as images; they can be used for ground characterization and monitoring.



4.3.4 Structural monitoring sensors

A. Sensors Description

Structural monitoring sensors will be installed by University of Perugia (UniPG) inside Consoli Palace in Gubbio. In particular, the monitoring system will comprise three high sensitivity piezoelectric uniaxial accelerometers model PCB 393B12 (10 V/g sensitivity) and two linear variable displacement transducers (LVDT) having 50 mm measurement range, 0-10 V output range. Two thermocouples will also be installed in the Palace and used for temperature compensation purposes. Measurements from structural monitoring sensors will be continuously acquired through a data acquisition system model NI CompactDAQ-9132 with the following technical characteristics: 1.33 GHz Dual-Core Atom processor, 2 GB RAM, 16 GB SD storage and Windows Embedded Standard 7 operating system. The DAQ system will be equipped with a NI 9234 data acquisition module for accelerometers (24-bit resolution, 102-dB dynamic range, and anti-aliasing filters) and one NI 9219 module for LVDT sensors (4 Isolated channels, 24-bit resolution, ± 60 V measurement range, 100 samples per second). The system will be also complemented by a NI PXIe-1071 mounting a PXIe-8820 2.2 GHz Celeron 1020E Dual-Core, Windows 7, controller, to provide additional computational capabilities and redundancy to the system. With the support of Gubbio Municipality the data acquisition system will be connected via an Internet data link to the Laboratory of Structural Dynamics of University of Perugia for signal processing purposes and to the HERACLES platform.

UniPg will also carry on the microclimate dynamic monitoring of the project case studies, with the aim of assessing local environmental conditions in terms of air temperature ($^{\circ}$ C), surface temperature ($^{\circ}$ C), relative humidity (%), wind speed(m/s), wind direction ($^{\circ}$), air quality (CO, CO₂, PM5, PM10-ppm), and illuminance level (lx). Such an experimental monitoring campaign will be performed by means of a brand-new portable experimental equipment, named “payload”, specifically developed for the scope of HERACLES. The technical characteristics of the sensors are still in a “development” phase, but will allow to map, over both space and time, the above-mentioned parameters, in order to (i) investigate the parameters variability and to (ii) evaluate their impact on the case study sites.

B. Measured parameter or information or phenomenon, spatial/temporal resolution

Accelerometers will be used to measure accelerations at selected locations in the building (single point measurements) at relatively high sampling rates (e.g. 100 Hz) under excitations provided by traffic, wind, swinging bells and other possible dynamic loading events, such as earthquakes. LVDT sensors will be used to measure the time evolution of the amplitude of existing cracks within Consoli Palace, using a lower sampling rate (e.g. 1 sample per hour).

As an example, Figure 18 shows a 30-minute long time history of acceleration recorded on top of the Palace during preliminary investigations by UniPg, highlighting the effects of traffic and swinging bells. Similarly, Figure 19 shows the responses on top of the palace registered during far-field earthquakes occurred in November 2016 during the Central Italy seismic sequence.

Measured accelerations will be processed by UniPg for Structural Health Monitoring (SHM) purposes, that is, to highlight the possible development of a damage in the structure producing a change in its global dynamic response. Raw acceleration data will also be useful to highlight peak responses under exceptional dynamic loading conditions such as earthquakes, which could be used to setup alarm thresholds. Measured crack amplitudes will allow to check the stability of monitored cracks and to early highlight the possible initiation of a local failure mechanism in the form of an increasing crack at constant or increasing speed.

Measured accelerations and crack amplitudes will also be used to calibrate numerical Finite Element models of the Consoli Palace, developed by UniPg and used to carry on structural analysis under





relevant loading scenarios. The calibration will be carried on, for example by matching experimentally identified and numerically predicted modal parameters of the Palace.

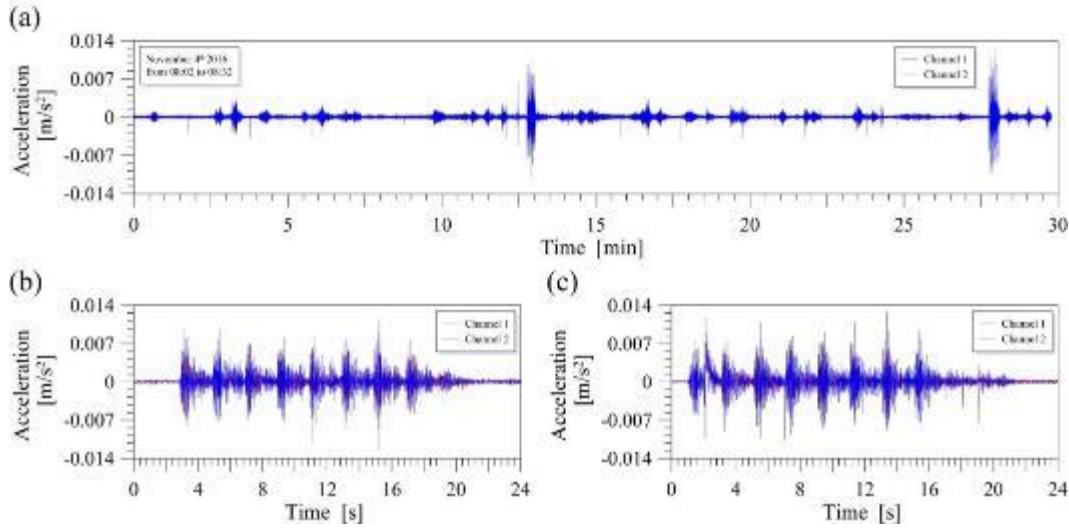

Figure 18: Example of measured acceleration time histories on top of the Consoli Palace in normal everyday conditions (a), highlighting the effects of traffic and of swinging-bells (in the detailed plots in b and c)

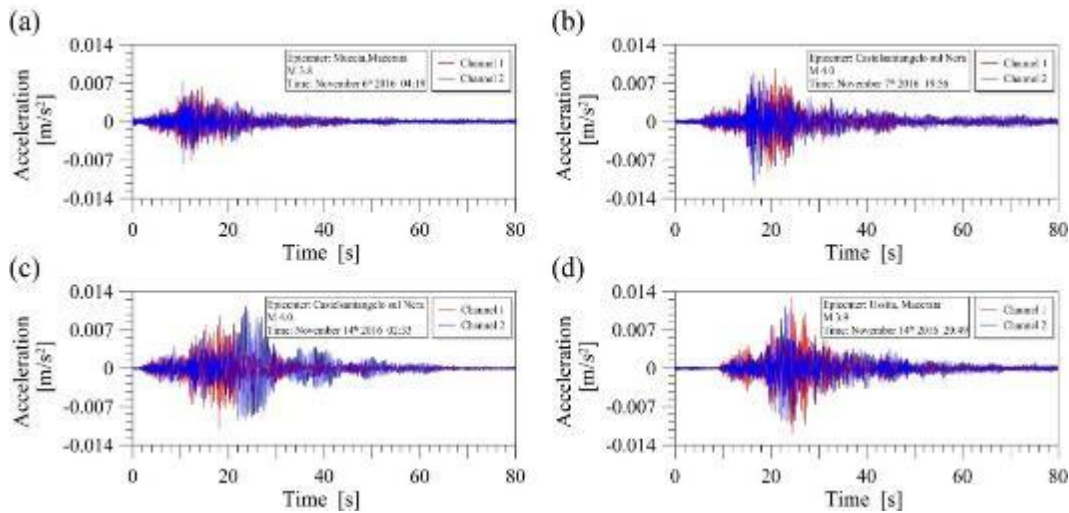

Figure 19: Example of measured acceleration time histories on top of the Consoli Palace during far-field earthquakes occurred in November 2016, during the Central Italy seismic sequence.

As an example, Figure 20 depicts the structural model of the Consoli Palace under development at UniPg.

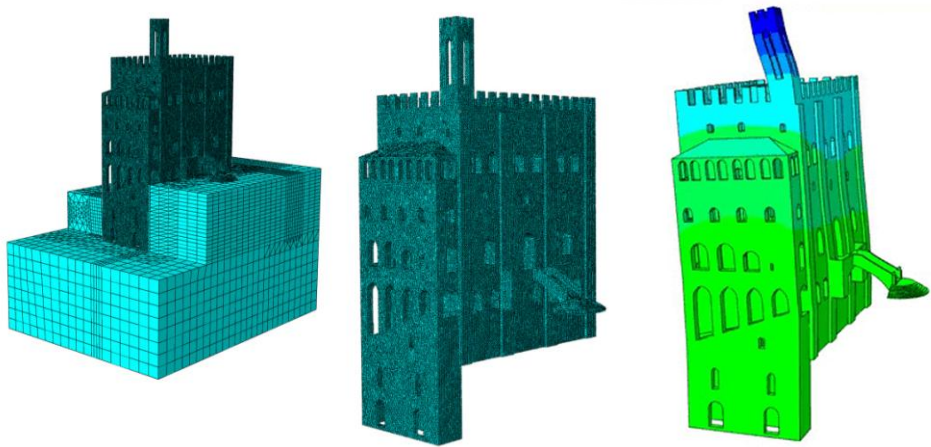

Figure 20: Numerical finite element model of the Consoli Palace under development at UniPg with view of the computational mesh (left and center) and of the first modal shape (right).

Examples of graphs and maps produced as outputs of the microclimate monitoring campaign (and consequent modelling) carried on by UniPg are shown in the following Figures 21, 22, and 23. The monitored environmental parameters will be used for the twofold purpose of: (i) characterizing the local microclimate conditions around the project case studies and (ii) calibrating and validating the elaborated numerical dynamic and microclimate models.

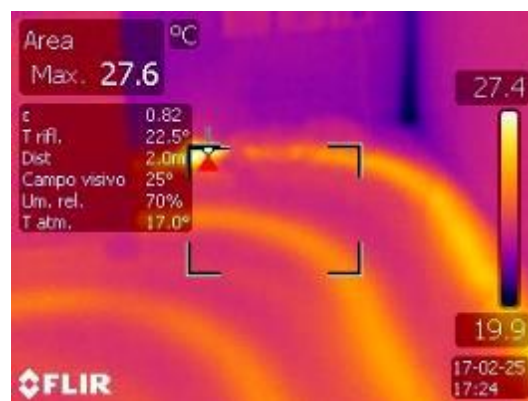

Figure 21: Example of output from the measurement of the surface temperature (°C) by means of infrared camera.

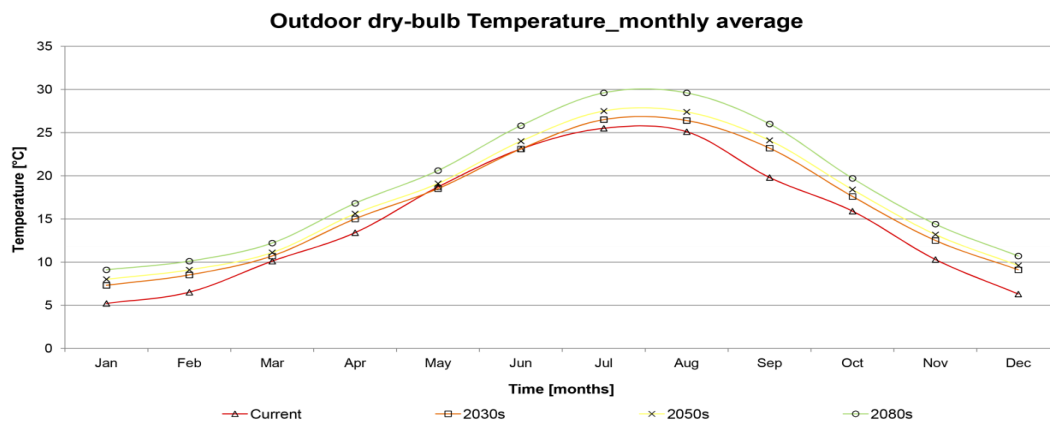

Figure 22: Example of output from the microclimate monitoring campaign: trend over time of the air temperature.



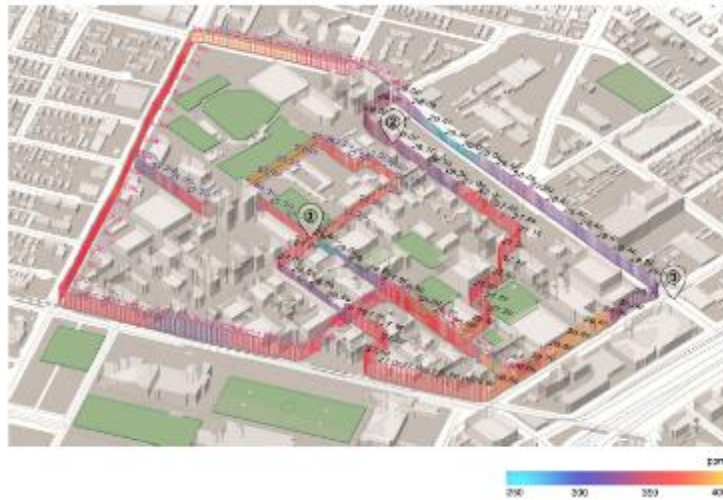

Figure 23: Example of microclimate monitoring output: Temperature and CO₂ concentration mapping obtained by carrying the payload around, at pedestrian level.

As an example, Figure 24 illustrates a typical output of the microclimate simulation. The produced outputs will be mainly of two types: (i) the plot of the collected environmental parameters versus time and (ii) 2D spatial and georeferenced maps showing the distribution of the selected parameters in the case study area. It must be pointed out that the payload is a prototypical monitoring equipment specifically developed for the purpose of the HERACLES project, therefore a few procedures for the post-processing of the collected data are still under development.

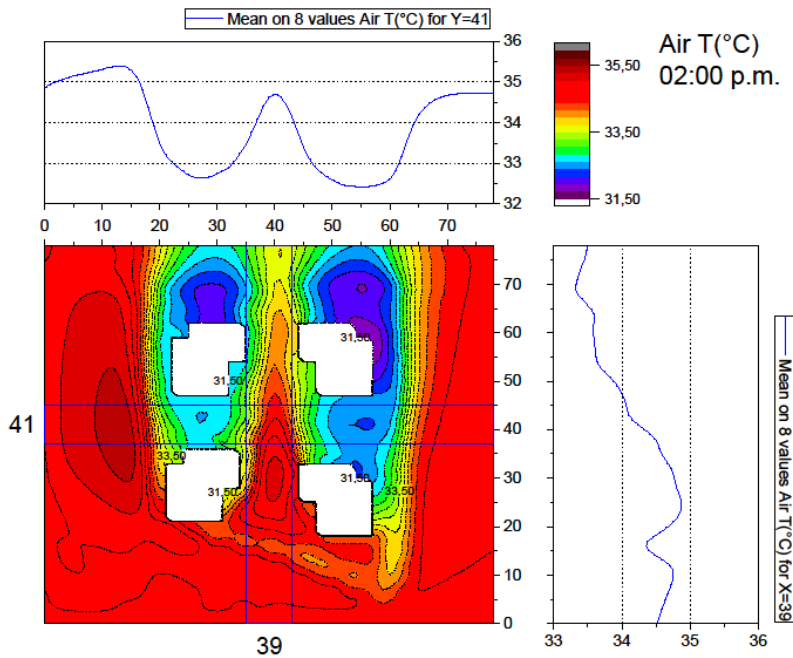

Figure 24: Example of microclimate simulation output: 2D spatial distribution of the air temperature on a site with the profile of the air temperature in specific selected sections of the site (blue lines graphs represent the mean value of air temperature).



C. Typology of data accessibility

Data will be accessible to all the HERACLES partners for scientific purposes. Data accessibility to third parties or for commercial purposes will be decided in agreement with the HERACLES Consortium.

D. Short description of the processing for output generation

Structural monitoring data will be processed by UniPg, using ad-hoc developed mathematical procedures for automated output-only modal identification and statistical process control. The aim of such a processing is to provide evidence of changes in the structural behaviour caused by damages, using a control chart such as the example plotted in Figure 25. In particular, this figure shows a control chart referring to a two years long monitoring activity carried out on a bell-tower in Perugia, Italy, clearly highlighting anomalies (damages) in correspondence of the red dashed lines. This kind of monitoring becomes effective once enough data have been acquired to fully characterize the normal conditions and to train the adopted statistical models. In the presented example, as well as in the case of the Consoli Palace, one year is estimated as the proper duration of the training period.

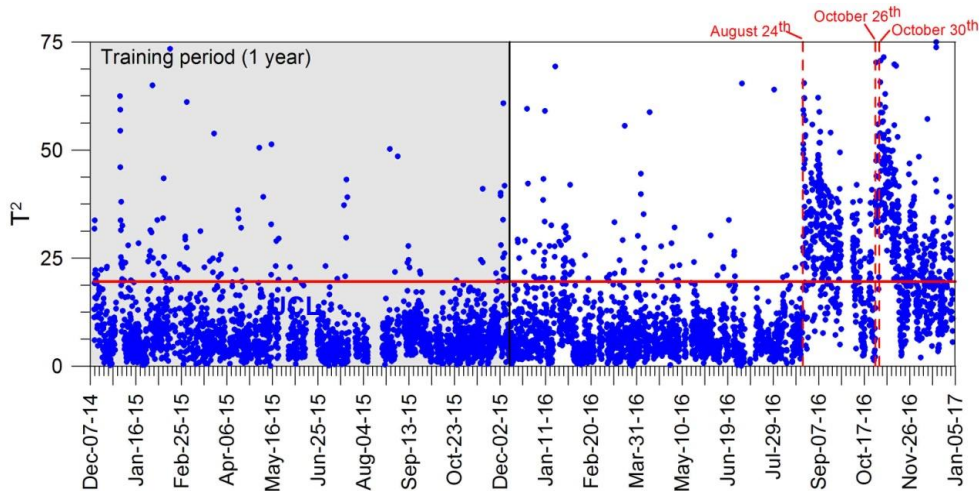

Figure 25: Example of control chart obtained as output of the statistical analysis of monitoring data with the occurrence of damages in correspondence to the vertical red lines [the control chart refers to a real structure located in Perugia and undergoing damage during Central Italy seismic sequence (2016)].

E. Spatial, temporal coverage and resolution on the HERACLES test-beds

The best spatial location for structural monitoring sensors will be selected in agreement with Gubbio Municipality. At this stage, it is envisaged to locate the three accelerometers on top of the Consoli Palace, with a configuration able to observe both bending and torsional modes, while the two LVDT sensors will be placed across two existing cracks in the building to measure crack amplitudes and their evolution in time. At this stage, two major cracks have been identified. The former regards a crack most likely indicating an overturning and consequent separation of the loggia, on the south front, with respect to the Palace. The second one is a vertical crack on the north façade that could be ascribed to differential settling of foundations or to past seismic events.

Data from accelerometers will be continuously recorded at 100 Hz and stored in separate files collecting 30 recording minutes. Data from LVDT sensors will be continuously recorded with a sampling time of 1 hour. Two thermocouples will be also installed to correlate the data fluctuations with the environmental conditions.





F. Output and relation to models

Output data will be formatted in ASCII files and will be used for structural analysis (FE modelling) and structural health monitoring purposes.

4.3.5 Meteorological – Oceanographical sensors

4.3.5.1 Meteorological Sensors

Description and specifications of the meteorological stations installed by the HERACLES partners are here provided for the Venetian fortress of “Koules” and the Knossos Archeological Site test-beds. Besides the data collected from dedicated weather stations installed in Koules and Knossos, for purposes of historical meteo data analysis, data from national Greek meteorological web portal will be collected. For what concerns Gubbio test-beds, meteo and air quality data will be collected from the weather stations managed by ARPA Umbria (*Agenzia Regionale per la Protezione Ambientale - Regional Environmental Protection Agency*) and for this reason no description is provided. Instead, the microclimate monitoring campaign was already described in the previous paragraphs.

A. Sensors Description

The two meteorological stations that will be installed on metal masts, 3-meter high. They are the Davis Vantage Pro2 Plus with 24-hr Fan-Aspirated Radiation Shield and UV & Solar Radiation sensors. The sensor suite combines an anemometer measuring wind speed, a direction vane measuring wind direction, a rain collector, a temperature and a humidity sensor. To increase the measuring accuracy, temperature and humidity sensors are housed inside a 24-Hour Fan-Aspirated Radiation Shield. The shield protects against solar radiation and other sources of radiated and reflected heat by moving the air through the shield 24-hours a day. Furthermore, an UV and a solar sensor are mounted on its hub for providing measurements on UV index and solar radiation, respectively. The stations will be protected against lightning strike and will be able to withstand wind speeds exceeding force 9 in the Beaufort scale.

B. Measured parameter or information or phenomenon, spatial/temporal resolution

The meteorological station will provide raw data (time series of wind speed and direction, temperature, humidity, rainfall, barometric pressure, solar radiation and UV Index), as well as graphical plots of the measurements. All data will be available online, and accessible via the HERACLES web page. All weather parameters will be recorded at 1 minute intervals. At intervals ranging from one to five minutes the weather station will generate and send a report to be displayed on the website and will upload the raw data (in ASCII format) to the database. For this purpose, the HERACLES platform/website will provide a dedicated page for weather reporting. The raw data will be transferred to the database via ftp protocol and stored there. The following tables (from Table 12 to Table 21) provide insight in the measured quantities with details concerning the measuring accuracy and sample rates.

C. Typology of data accessibility

The provided scientific data are time-series of the measured quantities, acquired for the specific points of measurement (Knossos and Koules test-beds). No relevant historic data are available for these sites. The data will be available when the two meteorological stations are in-place and the uplink to the HERACLES database has been established.





D. Short description of the processing for output generation

The sampling frequency of the measured data is 0.4Hz (1 / 2.5sec). The data are averaged on mean minute values. For every minute recording, a max, min and standard deviation values are provided for the measured quantity. Raw data and time-series report as well as measurement plots are updated and sent to the database at intervals ranging from one to five minutes.

E. Characteristics of the measurements on the test-beds

The provided meteorological data are pointwise information relevant to the location of the installed meteorological stations. The data will be made available when the two meteorological stations are in-place and the uplink to the HERACLES database has been established. The sampling frequency of the measured data is 0.4Hz (1 / 2.5sec). The data are averaged on mean minute values.

F. Data Usage

The use of the meteorological data is manifold:

1. For a full characterization of the local meteorological cycles over the test-beds, all provided data (shown in the following tables, from Table 12 to Table 21) will be required for a long period of time (at least one full sampling year, with minor data losses over the four annual periods).
2. The provided data will be cross-correlated with the satellite weather data for improving their accuracy. Using dynamical downscaling and forecasting computational techniques, artificial data series can be created to estimate the likelihood of cataclysmic events on short and long term future.
3. All weather data provided by the meteorological stations will be used as input with the corresponding satellite data for computational weather predictions and risk assessment analysis.
4. The meteorological stations are programmed to send “alarms” in case of some of the measured quantities exceeds preselected thresholds. This results very helpful for site monitoring and possibly for preventing the consequences of an extreme event. As an example, rapid drop in barometric pressure with increasing wind speed in specific wind direction sectors are usually signs of an oncoming storm front, which the meteorological station can easily monitor and then send the respective alarms.
5. For the Koules test bed, wind data can be combined with wave gauge data for the coastal hydrodynamic calculations.

The following tables (from Table 12 to Table 21) provide information on the measured quantities with details concerning the measuring accuracy and sample rates.

Table 12: Barometric Pressure

Barometric Pressure	
Resolution and Units	0.01” Hg, 0.1 mm Hg, 0.1 hPa/mb (user-selectable)
Range	16.00” to 32.50” Hg, 410 to 820 mm Hg, 540 to 1100 hPa/mb
Overall Accuracy	±0.03” Hg (±0.8 mm Hg, ±1.0 hPa/mb)
Update Interval	Every minute or when console Bar key is pressed twice





Table 13: Humidity

Inside Relative Humidity (sensor located in console)	
Resolution and Units	1%
Range	1 to 100% RH
Accuracy	±3% (0 to 90% RH), ±4% (90 to 100% RH)
Update Interval	1 minute
Alarms	High and Low Threshold from Instant Reading
Outside Relative Humidity (sensor located in ISS)	
Resolution and Units	1%
Range	1 to 100% RH
Accuracy	±3% (0 to 90% RH), ±4% (90 to 100% RH)
Temperature Coefficient	0.03% per °F (0.05% per °C), reference 68°F (20°C)
Update Interval	50 seconds to 1 minute
Extra Outside Relative Humidity (sensor located inside Temperature/Humidity Station)	
Resolution and Units	1%
Range	1 to 100% RH
Accuracy	±3% (0 to 90% RH), ±4% (90 to 100% RH)
Temperature Coefficient	0.03% per °F (0.05% per °C), reference 68°F (20°C)
Update Interval	50 seconds to 1 minute



Table 14: Rainfall

Rainfall	
Resolution and Units	0.01" or 0.2 mm (user-selectable)
Daily/Storm Rainfall Range	0 to 99.99" (0 to 999.8 mm)
Monthly/Yearly/Total Rainfall Range	0 to 199.99" (0 to 6553 mm)
Rain Rate	0 to 96" (0 to 2438 mm)
Accuracy	For rain rates up to 2"/hr (50 mm/hr): ±4% of total or +0.01" (0.2mm) (0.01" = one tip of the bucket), whichever is greater. For rain rates from 2"/hr (50 mm/hr) to 4"/hr (100 mm/hr): ±4% of total or +0.01" (0.25 mm) (0.01" = one tip of the bucket), whichever is greater
Update Interval	20 to 24 seconds

Table 15: Rain Rate

Rain rate	
Resolution and Units	0.01" or 0.1 mm (user-selectable) at typical rates
Range	0, 0.04"/hr (1 mm/hr) to 96"/hr (0 to 2438 mm/hr)
Accuracy	±5% for rates less than 5" per hour (127 mm/hr)
Update Interval	20 to 24 seconds

Table 16: Solar Radiation

Solar Radiation	
Resolution and Units	1 W/m ²
Range	0 to 1800 W/m ²
Accuracy	±5% of full scale (Reference: Eppley PSP at 1000 W/m ²)
Update Interval	50 seconds to 1 minute (5 minutes when dark)





Table 17: Inside Temperature

Inside Temperature (sensor located in console)	
Resolution and Units	Current Data: 0.1°F or 1°F or 0.1°C or 1°C (user-selectable) °C is converted from °F rounded to the nearest 1°C, Historical Data and Alarms: 1°F or 1°C (user-selectable)
Range	+32° to +140°F (0° to +60°C)
Sensor Accuracy	±1°F (±0.5°C), (see Fig. 1)
Update Interval	1 minute
Outside Temperature (sensor located in ISS)	
Resolution and Units	Current Data: 0.1°F or 1°F or 0.1°C or 1°C (user-selectable) nominal °C is converted from °F rounded to the nearest 1°C Historical Data and Alarms: 1°F or 1°C (user-selectable)
Range	-40° to +150°F (-40° to +65°C)
Sensor Accuracy	±1°F (±0.5°C) above 20°F (-7°C), ±2°F (±1°C) under 20°F (-7°C) (see Fig. 2)
Update Interval	10 to 12 seconds
Extra Temperature Sensors or Probes	
Resolution and Units	Current Data: 1°F or 1°C (user-selectable) °C is converted from °F rounded to the nearest 1°C, Historical Data and Alarms: 1°F or 1°C (user-selectable)
Range	-40° to +150°F (-40° to +65°C)
Sensor Accuracy	±1°F (±0.5°C) above 20°F (-7°C), ±2°F (±1°C) under 20°F (-7°C) (see Fig. 1)
Update Interval	10 to 12 seconds (77 to 90 seconds for Leaf Wetness/Temperature and Soil Moisture/Temperature Stations)



Table 18: Temperature Humidity Sun Wind Index

Temperature Humidity Sun Wind Index	
Resolution and Units	1°F or 1°C (user-selectable) °C is converted from °F rounded to the nearest 1°C
Range	-90° to +165°F (-68° to +74°C)
Accuracy	±4°F (±2°C) (typical)
Update Interval	10 to 12 seconds

Table 19: Ultra Violet (UV) Radiation Dose

Ultra Violet (UV) Radiation Dose	
Resolution and Units.	0.1 MEDs to 19.9 MEDs; 1 MED above 19.9 MEDs
Range	0 to 199 MEDs
Accuracy	±5% of daily total
Update Interval	11 seconds to 1 minute (5 minutes when dark)

Table 20: Ultra Violet (UV) Radiation Index

Ultra Violet (UV) Radiation Index	
Resolution and Units.	0.1 Index
Range	0 to 16 Index
Accuracy	±5% of full scale (Reference: Yankee UVB-1 at UV index 10 (Extremely High))
Update Interval	11 seconds to 1 minute (5 minutes when dark)



Table 21: Wind

Wind Chill (Calculated)	
Resolution and Units	1°F or 1°C (user-selectable) °C is converted from °F rounded to the nearest 1°C
Range	-110° to +135°F (-79° to +57°C)
Accuracy	±2°F (±1°C) (typical)
Update Interval	10 to 12 seconds
Wind Direction	
Range.	0 – 360°
Display Resolution	16 points (22.5°) on compass rose, 1° in numeric display Accuracy, ±3°
Update Interval	2.5 to 3 seconds
Wind Speed	
Update Interval	Instant Reading: 2.5 to 3 seconds, 10-minute Average: 1 minute
Accuracy	±2 mph (2 kts, 3 km/h, 1 m/s) or ±5%, whichever is greater



4.3.5.2 Oceanographic sensors

A. Sensors Description

The RBRduet T.D. (Figure 26) wave gauges measuring water level and sea temperature will be deployed in the sea bottom in front of the test bed of Koules. Their small compact size allows to be installed in a base near the sea bottom. The RBRduet has two channels submersible temperature and depth logger that will allow long term stay.



Figure 26: RBRduet sensor (left) and example of an installation base (right).

B. Measured parameter or information or phenomenon, spatial/ temporal resolution

The wave gauges will provide raw data (time series of sea level and temperature). All data will be available online, and accessible via the HERACLES website after acquisition and processing. All parameters will be recorded at 2Hz intervals. The raw data will be stored and processed locally: the processed data will be then transferred to the database via ftp protocol for the storage. The RBRduet is calibrated to an accuracy of $\pm 0.002^{\circ}\text{C}$ (ITS-90 and NIST traceable standards) and accuracy of 0.05% full scale for pressure (between -5°C and 35°C). The standard thermistor has a time constant of approximately 1.0 second. The RBRduet T.D has a measurement range of -5°C to $+35^{\circ}\text{C}$ in its standard calibration.

C. Typology of data accessibility, time coverage

The provided scientific data are time-series of the measured quantities, acquired for specific points of measurement. There are no relevant historic data for these sites. The data will be made available after that the two wave gauges stations will be in-place.

D. Short description of the processing for output generation

The sampling frequency of the measured data is 2Hz. The pressure data will be corrected with the use of the barometric pressure measurements from the meteorological station of Koules averaged on mean minute values. For every minute value, a max, min and standard deviation values are provided for the measured quantity. The raw data and the graphical time-series report and measurement plots are updated and sent to the database at intervals ranging from one to five minutes.



E. Characteristics of the measurements on the test-beds

The provided oceanographic data are point data focusing only on the location of the installed positions. On the other hand, combined with the data from the meteorological stations, they can provide information about the wave status in the wider area of Koules Fortress. An example of measured time series is presented in Figure 27.

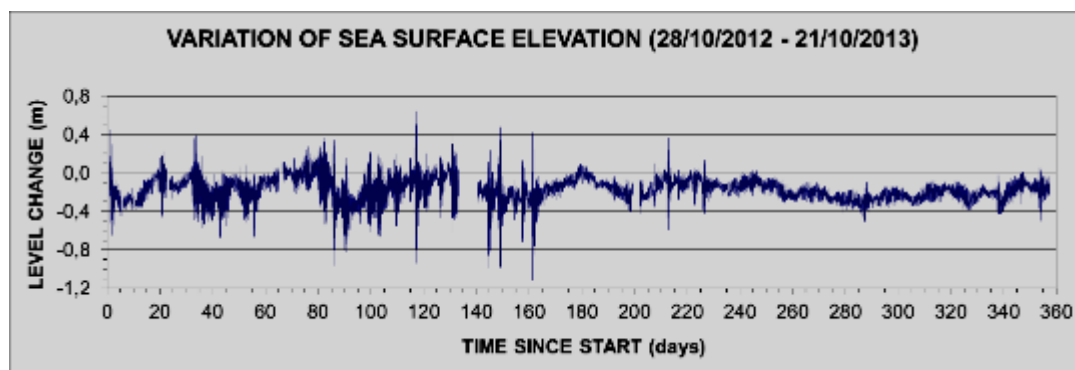

Figure 27: Example of a sea level variation plot.



4.4 Material Characterization Methodologies

In order to propose new solutions and new procedures for an effective preventive maintenance and conservation, a detailed knowledge of the materials constituent the CH assets and their degradation mechanism, is required. To achieve this objective, the proposed methodological approach is the following:

- 1) Evaluation of the analytical strategies, in terms of techniques to apply to the different CH assets, and definition of an analytical protocol.
- 2) In-situ diagnostic studies through not or minimally invasive *in-situ techniques* (spectral imaging, LIBS, Raman, etc.).
- 3) Ex-situ studies in laboratory to better characterize the structural, chemical and physical properties of the materials. These **(ex-situ) analyses** will be focused on the identification of materials and determination of their alteration/deformation mechanism by using high-resolution sophisticated measurements. A brief presentation of the techniques is provided in the following Table 22, while further information is given in the following, dedicated sections.

Table 22: Summary table of the in-situ and ex-situ characterization techniques described in dedicated sub-sections

Method	HERACLES partner	Analytical capacity of the techniques and its role within the HERACLES
IN-SITU (PORTABLE) TECHNIQUES		
Portable Multispectral Imaging system	FORTH-IESL	An imaging technique that combines digital imaging with spectroscopic analysis and may remotely and non-invasively give spatial and spectral information about an object and/or a monument.
Portable Raman spectroscopy system	FORTH-IESL	A non-destructive laser based technique that probes vibrational, rotational and other low-frequency modes (motions) in molecules and materials.
Portable Laser Induced Breakdown Spectroscopy (LIBS)-system	FORTH-IESL	Laser based technique provides information on the elemental composition of the area under analysis. LIBS is fast, has no particular sampling requirements and is suitable for fast screening of materials/areas.
4D Surface/ Volume Topography	FORTH-IESL	A non-invasive, non-destructive, portable and low cost technique to





portable prototype		measure the topology of a surface and its variations over the time (4D)
In-situ analysis/techniques for mechanical characterization	CNR-ISMN, UniPG, UoC	A number of techniques that will enable the HERACLES consortium to measure the mechanical properties of the lithotypes.
ex-SITU (LABORATORY) TECHNIQUES		
SEM-FIB (with EDS) - Scanning Electron Microscopy	UNINOVA UoC CNR-ISMN	SEM gives valuable information regarding the morphology and the texture of the sample under testing. This data (mostly qualitative) are extremely useful, because they document the current morphological status of the object under study, but they can also drive and guide consolidation efforts. EDS gives chemical element information, complementary to other techniques, such as XRD, XRF and XPS.
X-ray Diffraction (also micro) XRD	UNINOVA UoC CNR-ISMN	X-ray Diffraction is one of the most useful ex-situ characterization techniques. Although it is not a destructive technique itself, it requires sampling the site/object under study. However, it can give definitive information on the mineral phases present in the sample (qualitatively and quantitatively).
X-ray Fluorescence (also micro) XRF	UNINOVA	X-ray fluorescence is a powerful characterization technique for the study of cultural heritage materials: it provides the elemental chemical composition in a non-destructive way, needing almost no sample preparation for qualitative or semi-quantitative results.
TG-DTA and DSC Thermogravimetry, Differential Thermal Analysis and Differential Scanning Calorimetry	UNINOVA UoC	TGA-DTA offers characterization data of the sample under study regarding its behaviour under thermal stress. It studies mass loss of the sample as the temperature is increased (usually volatile molecules,



		such as water, are released). Although it can reach temperatures up to several hundred degrees Celsius, the useful range is much lower (eg. up to 120 C).
micro Raman	UNINOVA	Micro (μ)-Raman microscopy permits to obtain information on inert inclusions, neo-formed crystals and microcrystalline structures of cultural heritage assets, being a non-destructive method.
Confocal Laser Scanning Microscopy, not portable	UNINOVA	The confocal laser microscopy generates accurate three-dimensional imaging revealing detailed information regarding structures in the samples. This technique is particularly well suited for cultural heritage materials since it is non-destructive and non-invasive, while allowing surface topography of samples.
Stereo microscopy, not portable	UNINOVA	Stereo microscopy using reflected light is a particularly useful technique for surface observation of cultural heritage materials. It offers several modes of observation leading to different applications, high resolution topographic contrast and structural contrast.
FTIR - Fourier Transform Infrared Spectroscopy, not portable	UNINOVA, INSTM (Third Party), UoC	FT-IR is an useful ex-situ technique that supplements the material characterization by studying the vibrational modes of chemical groups present in the sample. It is extremely useful in characterizing organic consolidants used for stone/material consolidation.
Ellipsometry, not portable	UNINOVA	Spectroscopic ellipsometry provides accurate measurements of materials optical and structural properties of a broad range of materials allowing for the determination of surface chemistry features, constituent and void fractions roughness, indexes of



		refraction and area mapping
AFM - Atomic Force Microscopy, not portable	CNR-ISMN UNINOVA, UoC	AFM is mainly used in surface characterization and can be useful in ageing, conservation and cleaning effects studies of materials surfaces for the assessment of coatings and protective layers behaviour and measurement of the size of aggregates. It allows the characterization of the surface of samples taken from the site, showing degradation for the study of the decay mechanisms.
Spectrophotometry (UV-Vis-NIR)	UNINOVA, UoC	UV-vis spectroscopy is a technique that studies electronic transitions in materials (either in liquid or solid form). Although it finds limited application in CH field, it can be applied on solid samples to enrich characterization.
Porosimetry (Archimedes) and helium picnometry	UNINOVA, INSTM (Third Party)	The determination of porosity and density of materials from the three test-beds will allow for a cross-correlation among materials used in the different monuments, building techniques and state of conservation.
X-ray photoelectron spectroscopy (XPS)	CNR-ISMN	XPS is a unique analytical technique in providing chemical state information of the detected elements. XPS can be used to analyse the surface chemistry of a material and is routinely used to analyze a wide range of materials from inorganic compounds, glasses, ceramics, stones, etc.
Non-linear Microscopy	FORTH-IESL	A type of laser scanning microscopy, able to investigate materials with emphasis to selenite with the aim to discriminate the thickness between the different layers of these multi-layer structures at microscopic level and eventually assess the effectiveness of the new materials to



		be developed.
DSC Differential Scanning Calorimetry, not portable	INSTM (CVR-Third party), UoC	Same as 4.4.2-4
Analyses/techniques concerning the mechanical, thermo-physical characterization of concrete, mortars, binders and stones	INSTM (CVR-Third party), UniPg	They include analyses/techniques concerning the mechanical, thermo-physical characterization of concrete, mortars, binders and stones.

4.4.1 In-situ

In the following sub-sections, a description of the in-situ techniques selected for the purposes of the HERACLES project, is provided.

4.4.1.1 Multispectral Imaging (MSI)

Multispectral Imaging (MSI), fully described in D3.2, is a diagnostic technique which combines digital imaging with spectroscopic analysis in order to recover spatial and spectral information about an artifact. In general, imaging techniques require a source to illuminate the object to be depicted and an imaging sensor able to capture the light backscattered from the object. For the purposes of MSI, a monochromator, most often a series of bandpass filters, is positioned in the light path either in front of the illumination system or in front of the imaging sensor. The outcome of this technique is a set of successive images, one spectral image for each spectral band, called spectral cube. Further processing of the spectral cube leads to the extraction of useful information about the materials constituting the object under study. The advantage of MSI resides in its contactless and non-invasively features.

MSI has been proved to be a useful tool for restorers, archaeologists and art-historians [4]. Stratigraphic analysis [5], monitoring of deterioration phenomena or conservation interventions [6] and enhancement of faded patterns are among the potentials of MSI in cultural heritage (Figure 28).



Figure 28: (left) The IRIS-II system, (center) the object under study and (right) the recorded spectral images at different spectral bands.

MSI contribution to HERACLES

MSI will contribute to the in-situ, non-invasive remote mapping of the various weathering features of the CH assets/monuments, such as efflorescence salts and other crusts, as well as contribute to the monitoring of their progress and expansion on the affected areas, during time. For this purpose





campaigns will be carried on and scheduled at definite time intervals in order to capture spectral images of the area of interest under different seasonal and weather conditions. The data will be regularly processed and compared with data related to the past campaigns. In this way, the evolution of weathering features will be monitored and the relative environmental conditions effects will be assessed. The technique and the system is fully described in D3.2.

4.4.1.2 Portable RAMAN

Raman spectroscopy is a well-known analytical technique that probes vibrational, rotational and other low-frequency modes (motions) in molecules and materials. As a result, it provides an accurate look into chemical bonding, thereby enabling identification of various types of materials, both inorganic and organic. The technique and the system is fully described in D3.2.

For the purposes of the HERACLES project the portable Raman system will be used to determine the nature and composition of a number of weathering formations in different areas of the monuments, such as pollution crusts, biodegradation and salt efflorescence.

4.4.1.3 Portable Laser Induced Breakdown Spectroscopy (LIBS)

Laser Induced Breakdown Spectroscopy (LIBS) is an analytical technique that enables the determination of the elemental composition of materials on the basis of the characteristic atomic emission from a micro-plasma produced by focusing a high-power laser on or in a material. The LIBS technique has been used in a wide variety of analytical applications for the qualitative, semi-quantitative and quantitative analysis of cultural heritage materials in oil paintings and frescoes, stone and metal sculpture, pottery, glass etc. [7, 8, 9]. The LIBS technique is described in detail in D3.2.

Along the HERACLES project LIBS will be used to support the characterization of salt crystallization processes by analysis of samples in the laboratory and direct analysis of the efflorescence on the surfaces of the Koules Venetian Fortress and Knossos. Figure 29 shows typical examples of past in-situ analytical campaigns using the portable LIBS system developed by FORTH-IESL.

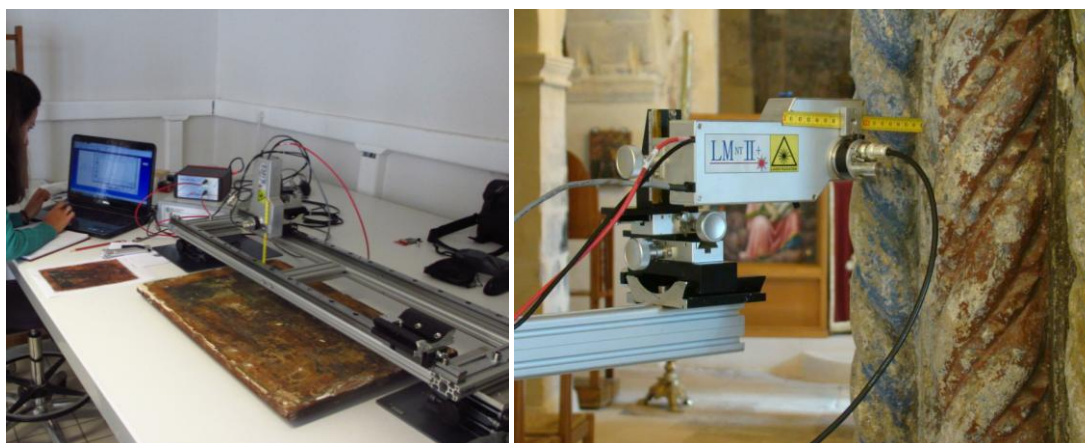

Figure 29: Analysis of Russian icons in the Byzantine and Christian Museum in Athens (left). Analysis of the door frame of the Church of St George in the village of Kamariotis [9] (right).



4.4.1.4 4D surface volume topography

4D topology device

The topology of a surface and its variations over time (4D) is measured by using two independent optical techniques in parallel. Both techniques are based on low coherence (white light) interferometry. They are both non-invasive, non-destructive, portable and low cost [10, 11, 12].

Spectral interferometry

Spectral interferometry uses the interference in the spectral domain to measure the topology of a surface. Its operational principle as well as typical results are shown in Figure 30.

The advantages of the technique are associated with the absence of moving parts: high repetition rate measurements with sub-wavelength precision ($<\lambda/70$) are therefore feasible. The disadvantages are related to the fact that the topological information are retrieved along a single line and that there is a maximum height difference that can be measured (typically $\sim 200 \lambda$).

The setup can be mobile, hand-held, and therefore it permits real time measurements. This technique is optimal for quick high resolution and repetitive measurements of the surface topology.

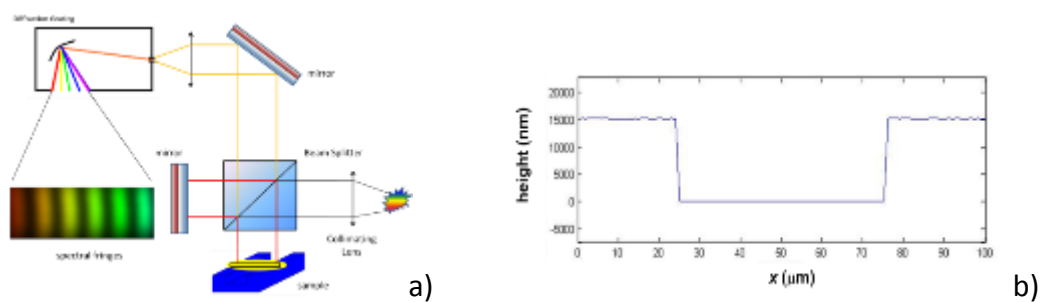

Figure 30: Basic principles of spectral interferometry (a) experimental setup (b) typical results

White light scanning interferometry

White light scanning interferometry uses the interference fringes from a low coherence source (white light) to measure the surface topology. The technique is a variation of classical interferometry, where the optical path of a reference arm in an interferometer is changed by moving a mirror. Due to the low coherence of the source, interference fringes are observed only for near zero optical path difference.

The advantages of the technique involve that it is capable of high resolution 2D surface topology measurements of sub-wavelength precision ($<\lambda/50$) without practical limits in the surface height. The disadvantages include that a scanning is required, the repetition rate is slow and anti-vibration control (passive or active) is needed during the measurement.

The setup can be mobile, capable of low repetition rate real time measurements (Figure 31). This technique is optimal for in depth, high resolution and measurements of the surface topology.

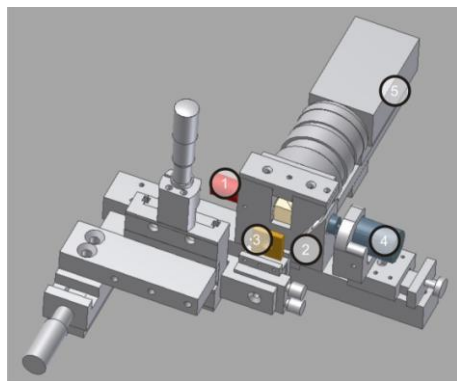

a)

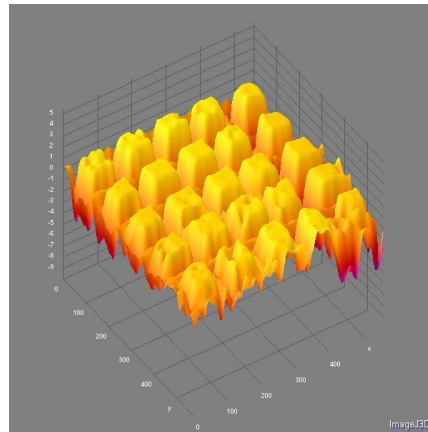

b)

Figure 31: White light scanning interferometry (a) experimental setup: (1) LED, (2) beam-splitter, (3) sample holder, (4) piezo (5) CCD (b) typical result: engraved glass with polymer coating

4.4.1.5 In-situ analysis/techniques for mechanical characterization

The following in-situ analysis/techniques concern the mechanical characterization of concrete, mortars, binders and stones with or without consolidants.

Pachometer test for rebar location: the test consists of the use of a rebaroscope to locate rebars in reinforced concrete elements in a fully non-destructive mode.

Schmidt hammer test on concrete: the test consists of an indirect measurement of the hardness of concrete in the form of a rebound number measured with a standard Schmidt hammer which can be correlated with concrete strength.

Ultrasonic test on concrete: the test consists of measuring the travelling speed of ultrasonic waves in concrete which can allow to detect cracks and to estimate concrete strength.

SONREB test on concrete: this is a combination of Schmidt hammer and ultrasonic test to achieve an improved estimation of concrete strength.

Flat jack test for masonry: this is a partially destructive test consisting of the insertion of flat jacks within the masonry. In single jack configuration the test allows to measure the stress within the masonry. In double jack configuration it also allows to measure the deformability and the strength of the masonry.

Instrumented hammer test: an instrumented hammer can be used to apply a measurable dynamic impulse to a structural element. An accelerometer can be used to measure the response at different locations that can help identifying voids and cracks in a structural element.



4.4.2 Ex-situ

4.4.2.1 Scanning Electron Microscopy – Focused Ion Beam [SEM-FIB (with EDS)]

SEM and FIB principles

SEM is a powerful technique capable of producing images with resolution ≈ 1 nm. High-energy electrons are thermionically emitted from a tungsten or lanthanum hexaboride cathode or, alternatively, generated via field emission, being then accelerated towards an anode. A condenser system composed by electromagnetic lenses focuses the electron beam into a fine probe (1-5 nm) that impinges on the specimen. The objective lens determines the resolution attainable by the microscope. The beam passes through pairs of scanning coils deflecting the beam horizontally and vertically over the sample surface. When the primary electron beam is focused on the material the electrons lose energy by recurrent scattering and absorption within a teardrop-shaped volume of the specimen. This interaction results in multiple effects such as secondary electrons (topographic information), backscattered electrons (atomic number contrast) and X-rays (elemental analysis).

FIB uses a primary beam of ions rather than electrons to interact with the sample. Ions are larger, heavier and have different polarity compared with electrons, bringing different imaging capabilities (e.g., grain orientation contrast, chemical contrast) and controlled nanoscale etching. Modern dual-beam systems have SEM and FIB columns for enhanced nanoanalysis/nanofabrication capabilities. With a gas injector system (GIS) nanoscale deposition and selective etching are achievable, decomposing a precursor gas in volatile and non-volatile species by the electron or ion beam.

Applications and contribution to HERACLES

Possible applications concern morphological, structural, elemental and electrical analysis of micro and nanostructured samples from different fields: material science, cultural heritage, microelectronics, geology, biology, chemistry, pharmaceuticals, forensic science, nano-fabrication (deposition/etching) and nano-manipulation (Figure 32). A specific interest of SEM-FIB is the prospect of collecting images during milling, by allowing for 3D reconstruction of points of interest in the samples with resolution at the nanometer scale.



Figure 32: SEM FIB images of a microprocessor, bacteria, ZnO nanowire and nano-circuits prepared by FIB

SEM has a widespread use in the structural analysis of materials from cultural heritage being usual coupled with EDS for an elemental chemical analysis. SEM-FIB (coupled with EDS) will contribute to HERACLES in the morphological and microstructural characterization of samples originating from the



test-beds and gives the opportunity of high resolution observation of the structural constituents with the possibility of elemental characterization of the observed spot.

Here, as an example (Figure 33) is shown an ancient ceramic section observed by SEM, where are visible the different component of the shard (ceramic body, different inclusions, glaze layer on top) [13].

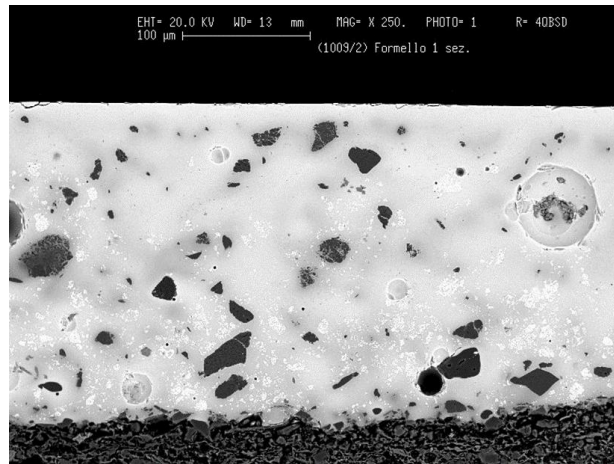

Figure 33: SEM image of a ceramic shard in section [13]

Electron Backscatter Diffraction (EBSD): Very powerful tool for microstructural characterization, including crystal orientation, grain size, global and local texture, recrystallization, strain analysis, phase identification and transformations.

Energy Dispersive X-ray Spectroscopy (EDXS): the interaction of primary electron beam with sample produces X-rays that provide qualitative and semi-quantitative elemental analysis. An example of the use of this technique is shown in Figure 34 [14].

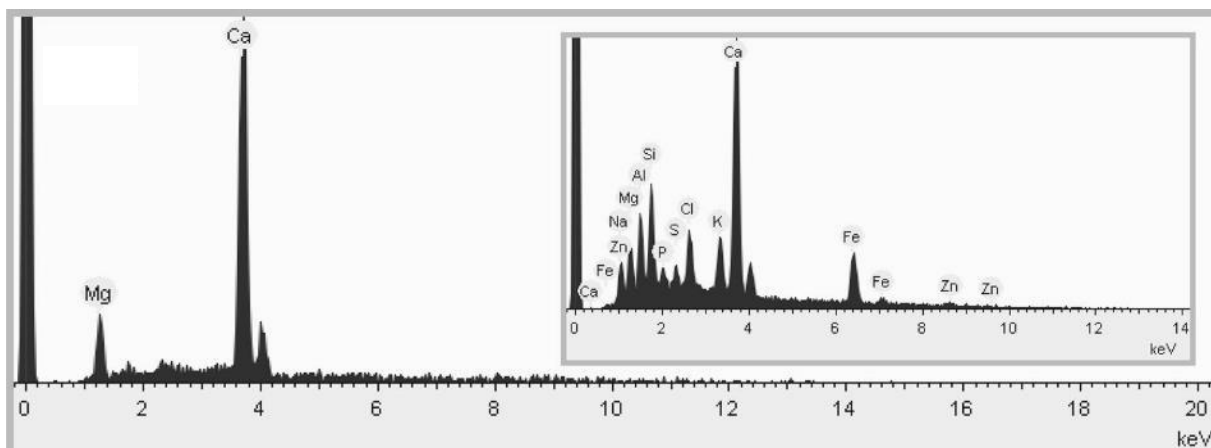

Figure 34: SEM-EDS spectra acquired on an Angera stone, showing the average composition. In the insert, spectrum acquired focusing the beam on single points is shown [14].



4.4.2.2 X-ray Diffraction (XRD) (also micro)

XRD Principles

X-Ray diffraction is a powerful and non-destructive technique for identification and quantification of the crystalline phase composition of powdered and solid materials. It is based on the photon elastic scattering by the atoms of a given material. When the atoms are positioned in a periodic array, the scattered radiation undergoes destructive and constructive interference (diffraction) at specific angles and this phenomenon is described by the Bragg's Law.

The directions of the diffracted wave depend on the size and shape of the unit cell, and the intensities depend on the arrangement of the atoms in the crystal. Therefore, a diffraction pattern reveals the crystalline phases present (peak positions), the relative phase concentration (ratio of peak areas), amorphous content (background humps) and crystallite size and strain (peak widths).

Conventional Configuration

Electrons from a hot filament are accelerated to the anode material (usually Cu or Mo) in a HT tube, to produce the X-rays. The rays are directed to the sample, and the diffracted beam is collected by a photodetector. The movements of detector and X-ray source relative to the sample surface are controlled in a diffractometer and different kinds of geometries can be chosen.

In the conventional Bragg-Brentano focusing geometry (Figure 35), the incidence angle is set equal to the diffracted angle (measured with respect to the sample surface) and data are usually plotted as Intensity vs. 2θ (related to interplanar spacing d_{hkl}) in a diffractogram. This configuration presents a high intense diffracted beam with very good 2θ resolution and is ideal for powder samples and polycrystalline films. Due to the symmetric angle geometry it mainly probes grains aligned parallel to the surface. However since the penetration depth depends on the incident angle, it has lower sensitivity for very thin films.

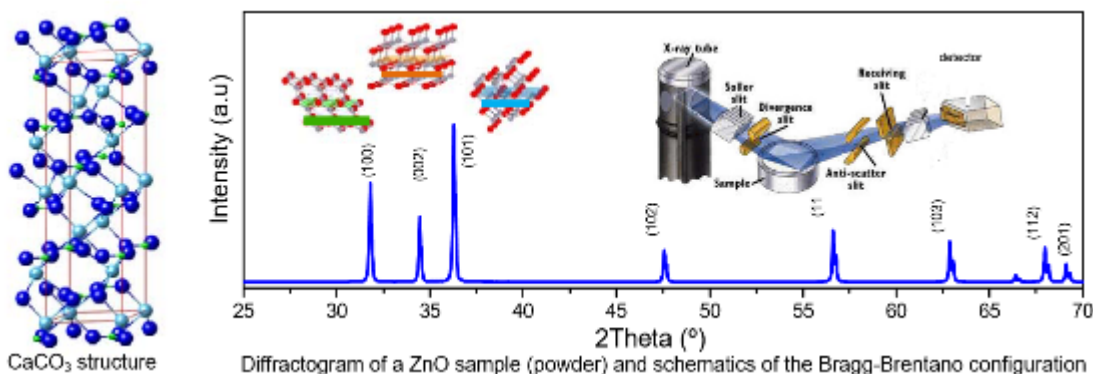

Figure 35: ZnO powder diffractogram with schematics of a X-ray diffractometer in the Bragg-Brentano geometry

Applications and contribution to HERACLES

XRD allows the phase Identification and composition by qualitative and quantitative analysis of powdered, bulk and thin film materials. A high range of applications are possible in diverse areas such as material science, cultural heritage, geology microelectronics, chemistry, pharmaceuticals and forensic science among others.

The sampling in HERACLES regards stones, binders, mortars, cements, minerals and related materials: all samples with crystalline phases are thus expected. Accordingly, XRD will be of major importance to





characterize the mineralogical constitution of all the samples. As it can also be done in a micrometric approach, even with a very low amount of samples, dependable results can be attained on the original and weathered materials. The analysis is non-destructive if the sample is already in an adequate format.

Here, as example, is shown the XRD study already carried out on clays of different origin, showing different and characteristic XRD patterns (Figure 36) [15].

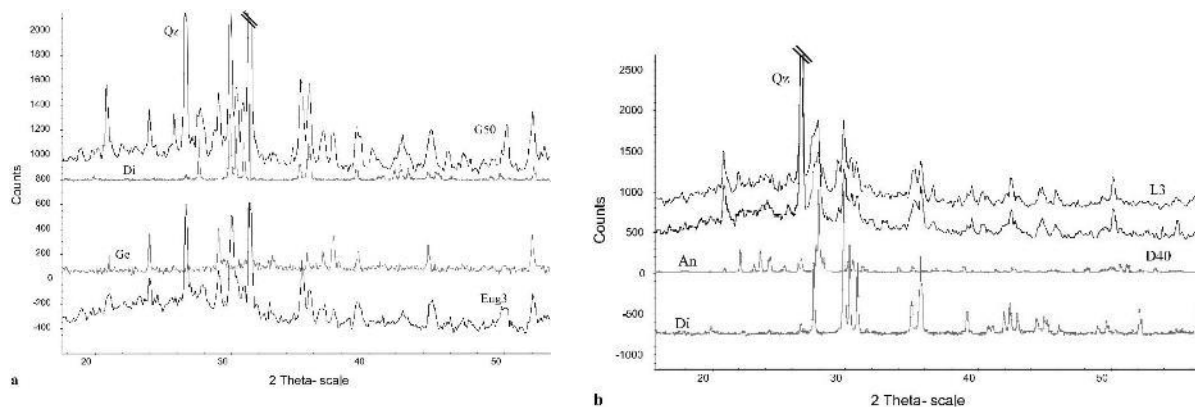

Figure 36: (a) XRD patterns acquired on Gubbio clay samples with the indication of two references gehlenite (Ge) and diopside (Di); (b) XRD patterns acquired on Deruta clay samples together with the two references diopside (Di) and anorthite (An), a kind of plagioclase [15].

Microdiffraction

Micro X-ray diffraction uses a capillary focusing optics to collect X-rays from the divergent X-ray source and to direct them to a focused beam at the sample surface with diameters of tens of μm . The increase of intensity in a small spot allows an enhanced spatial resolution for small feature analysis, such as for cultural heritage samples.

4.4.2.3 X-Ray Fluorescence Spectrometry (XRF)

Wavelength-dispersive X-ray fluorescence spectrometry (WDXRF) PANalytical AXIOS 4.0

This non-destructive analytical technique is used to identify and determine the concentrations of elements present in solid, powdered and liquid samples (Figure 37), capable of measuring chemical elements at trace levels often below ppm and up to 100%. X-ray Fluorescence occurs when an inner shell electron from a given chemical element is excited by an incident X-ray and is related to the de-excitation process of an electron which from a higher energy level fills the vacancy. The energy difference between the two shells appears as an X-ray emitted by the atom. The X-ray acquired spectrum reveals a sequence of characteristic peaks that allow for the identification of the elements present in the sample (qualitative analysis) while the peak intensity provides the relevant or absolute elemental concentration (semi-quantitative or quantitative analysis) (Figure 38). The analyses can be made under a helium flow or in vacuum.





Figure 37: XRF (PANalytical) apparatus and different typologies of samples that can be analysed for elemental chemical analysis

Sample preparation: Little or no special preparation makes it a valuable tool for cultural heritage materials, although samples should be presented in homogeneous and reproducible form. If adequate in size and with a flat surface, samples can be measured as they are.

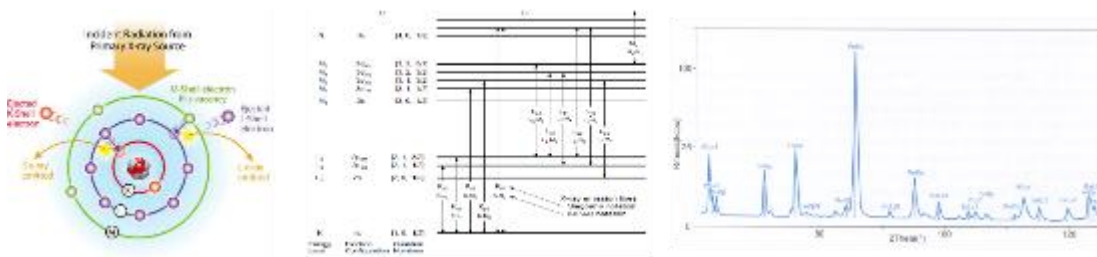

Figure 38: Electronic transitions in the atoms resulting in x-ray fluorescence emissions that are recorded in 2θ spectra for elemental chemical analyses.

Applications and contribution to HERACLES

A high range of applications are possible in diverse areas such as material science, cultural heritage, geology, microelectronics, chemistry, pharmaceuticals and forensic science among others. XRF is also one of the basic techniques employed in the characterization of cultural heritage materials. The elemental composition of the samples can be accurately determined in terms of weight percentages in a semi-quantitative approach or in a quantitative approach if a suitable array of standards is available and if the sample can be destroyed. A major advantage of the semi-quantitative approach is the possibility of a non-destructive analysis with high accuracy, being the sample available for other characterization techniques. Since the samples to be analyzed from the three test-beds are of mineralogical origin, they are particularly suited for this technique since the range of analyzed elements are from fluorine to uranium.

4.4.2.4 ThermoGravimetry-Differential Thermal Analysis (TG-DTA) and Differential Scanning Calorimetry (DSC)

Simultaneous Thermal Analysis generally refers to the simultaneous application of Thermogravimetry (TGA) and Differential Scanning Calorimetry (DSC) to one and the same sample in a single instrument. The advantages are obvious: the test conditions are perfectly identical for the TGA and DSC signals (same atmosphere, gas flow rate, vapor pressure on the sample, heating rate, thermal contact to the sample crucible and sensor, radiation effect, etc.). Furthermore, sample throughput is improved as more information can be gathered from each test run.





DSC - TG Principles

It is a technique that can be used to characterize the energy phenomena produced during heating (or cooling) of a substance (or a mixture of substances) and to determine the changes in the enthalpy and specific heat and the temperature at which these occur. DSC measures the change of the difference in the heat flow rate to the substance and to a reference material when they are subject to a controlled temperature program.

TG – Thermogravimetry

TG is a technique in which the mass of a sample of a substance is recorded as a function of temperature according to a controlled temperature program.

With DSC technique, a sample is placed inside a crucible: the latter is then placed inside the furnace of the DSC system along with a reference pan that is normally empty. By applying a controlled temperature program (heating or cooling at constant rates), caloric changes can be measured (Figure 39).

Applications and contribution to HERACLES

The technique is suitable for the determination of specific heat, transition enthalpies (polymorphism), melting temperatures, melting enthalpy, degree of crystallinity, crystallization temperatures/enthalpy, phase transformations and diagrams, glass transition temperatures & Cp (heat capacity of a material), decomposition effects, reaction enthalpy, thermokinetics, purity determinations, Solid Fat Index (SFI), mass changes, temperature stability, oxidation/reduction behaviour, decomposition, corrosion studies, compositional analysis. For HERACLES materials to be analyzed, the main advantage is that a very small amount of sample is necessary, about 70 µl, being particularly appropriate for controlled monitoring in time and temperature of physical and chemical properties of the substances and reaction products of the materials used in the test-beds. For example, thermogravimetric essays are quantitative with variations in mass being measured over reactions. In differential analysis a qualitative characterization is allowed for thermal processes as endothermic, exothermic, reversible or irreversible of physical or chemical alterations in the samples (fusion, dehydration, carbonate decomposition, crystallization).

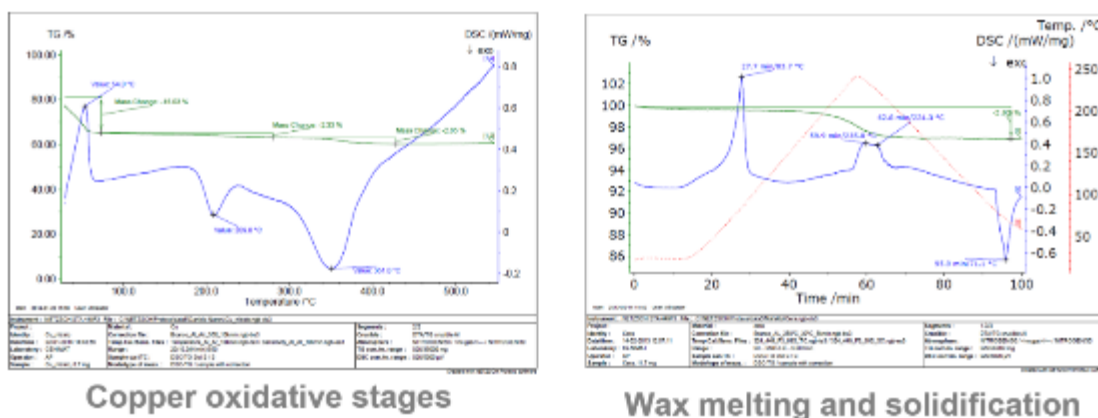

Figure 39: TG - DSC curves of the different oxidative stages of copper and melting and solidification cycle of wax.

4.4.2.5 Differential Scanning Calorimetry (DSC)

Differential scanning calorimetry (DSC) monitors heat effects associated with phase transitions and chemical reactions as a function of temperature and how the heat capacity of a material (C_p) is





changed by temperature. In DSC, the difference in heat flow to the sample and a reference at the same temperature is recorded as a function of temperature. The reference is an inert material such as alumina or just an empty aluminum pan. The temperature of both the sample and reference are increased at a constant rate.

DSC application in binder gives information on the thermal power (heat production rate) produced by the hydration reactions. The timing and shape of the heat flow curve obtained by calorimetry is an indicator of relative performance of binders and of potential adverse interactions between materials used in the mixture. [16]

4.4.2.6 micro Raman spectroscopy

Principle

Raman spectroscopy is a technique based on the inelastic scattering of monochromatic light, usually from a laser source, which provides chemical information. When light interacts with a sample excites molecules, inducing oscillating dipoles and it is usually scattered without any change in energy, elastic or Rayleigh scattering. But a small portion of the incident photons (1 in a 10⁶ reemitted photons) are scattered inelastically due to their interaction with the vibration or rotation of atoms or molecules. The frequency of these reemitted photons is shifted in comparison with the original monochromatic frequency, which is called the Raman effect. The shift in frequency can be a consequence of part of the photons energy transferred to the Raman-active mode and the resulting frequency of scattered light is reduced – Stokes scattering. In other case, a photon is absorbed by a Raman-active molecule, which, is already in the excited vibrational state. Consequently, excessive energy of excited Raman-active mode is released, and the resulting frequency of scattered light increases – Anti-Stokes scattering. Because molecules vibrate at a particular set of frequency, this change provides information about vibrational, rotational and other low frequency transitions in molecules. Hence, is specific to the individual molecules giving a fingerprint Raman spectrum of the material.

Key Features of the available apparatus

High optical efficiency; high spectral resolution, stability and bandwidth; broad-range artefact-free spectra; Low wavenumber performance; highly sensitive detectors; truly confocal performance; high performance microscope; extended sample viewing; multiple lasers; high quality Raman images; Fully automated.

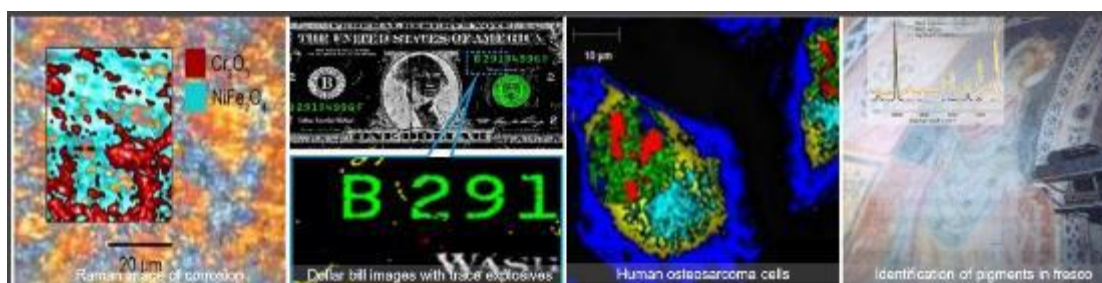

Figure 40: Examples of Raman imaging: corrosion in thin films, forensic examination of gunshot residue, observation of cells and identification of pigments in fresco paintings

Applications and contribution to HERACLES

Micro-Raman spectrometers can be used in any application where non-destructive, microscopic, chemical analysis and/or imaging is required. It allows to rapidly characterize the chemical composition and structure of a sample, whether solid (particles, pellets, powers, films, fibers), liquid (gels, pastes) or gas (Figure 40). Little or no sample preparation is required and it is a label-free technique, which reduces the potential danger for cultural heritage artifacts. It is possible to analyze





samples multiple times and to generate correlative and complementary information using downstream techniques. This technique is particularly suited for HERACLES available samples from the test-beds since it allows to obtain information regarding microcrystalline structures in mineralogical and ceramic related materials and on inert and neo-formed crystalline phases in original and weathered constituents.

4.4.2.7 Confocal Laser Scanning Microscopy

Confocal Principle

The LSM 700 is a light microscopy system that uses laser light in a confocal beam path with the aim to capture defined optical sections of the material sample and combine them into a three-dimensional image stack. The basic principle behind confocal microscopy is the use of spatial filtering to generate a focused point of illumination combined with a pinhole at the image plane in such a way that the out-of-focus light does not reach the detector. Only light focused at the pinhole passes through it, all the other light is scattered.

Since this solution only provides information about a single point at one time, in order to build an image, the focused spot of light must be scanned across the specimen. The precise optical sectioning of thick specimens is provided by a motorized z-axis drive. It is thereby possible to generate precise three dimensional data sets that can be reconstructed into models of the sample in 3D space. This provides structural properties and reveals detailed information regarding the structures localization within the sample.

Applications and contribution to HERACLES

Morphological, topographic and structural characterization of microstructured samples from different fields are possible, with application in material science, cultural heritage, microelectronics, geology, biology, chemistry (Figure 41 and Figure 42). Co-localization analysis (detection of emissions from two or more fluorescent molecules) is also possible.

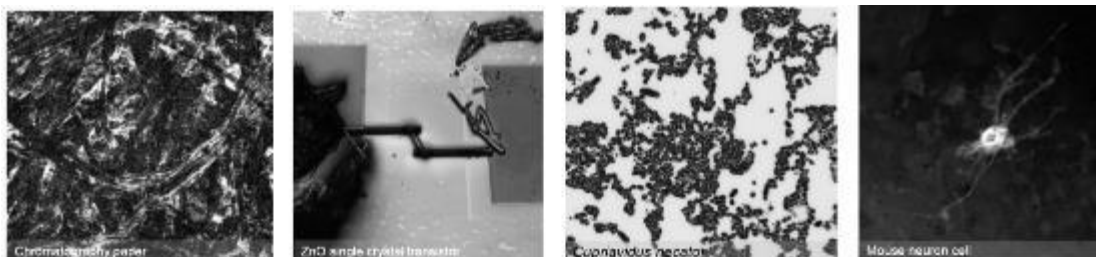

Figure 41: Examples of different types of materials observed under a confocal laser microscope: chromatography paper, ZnO single crystal transistor, bacteria and a neuron cell.

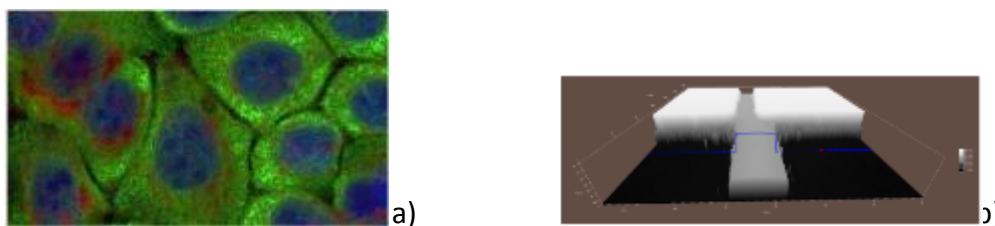

Figure 42: Example of a) Fluorescence confocal microscopy mode showing co-localization analysis of cancer cells (green) incubated with gold nanoparticles (red) and b) 3D surface topography with section of measured profile of a PDMS microfluidic channel



This technique is particularly well suited to observe weathered samples from built heritage from the test-beds since it allows for high spatial resolution for 3D imaging in very small specimen areas for the detection of algae, cyanobacteria, lichens and fungi. Being a non-destructive and non-invasive method it allows for the examination of surface topography of materials.

4.4.2.8 Stereo microscopy

Reflected Light (Optical) Microscope

Leica DMI5000 M is an inverted reflected light microscope, incorporating a motorized stage. Reflected microscopes are used to observe and to analyze surfaces or cross-sections of opaque specimens and have a wide application in cultural heritage samples observation from ceramic to metals (Figure 43). The motorized stage, microscope, and digital camera are controlled by LAS software. This automation allows the acquisition of increased depth field images (MultiFocus) and the grouping of sequential images (MultiStep). The installed microscope has four different imaging contrast modes: Brightfield (BF), Darkfield (DF), Interference Contrast (IC) and Polarized Light (PL) (Figure 44).



Figure 43: Leica Microscope and image in bright-field mode of a metallic sample



Figure 44: Metallic surface observed in different modes: Brightfield, Darkfield, Interference contrast and polarized light.

Applications and contribution to HERACLES

With a wide application in the surface observation of materials, the technology offers several modes of observation with different applicability and is particularly fitted to the observation of the different material from the test-beds of the HERACLES project:

Brightfield - The BF mode is the simplest of all the optical microscopy illumination techniques. In general, it produces a natural illumination of the specimen (Natural colours and reflective properties contrast).



Darkfield - The DF mode blocks out the central light rays along the optical axis of the microscope. Only oblique rays, originating at large angles, striking the specimen are used (Topographic contrast).

Interference Contrast (IC/DIC) - In IC, a Nomarski prism splits the polarized light rays into two orthogonal polarized beams on their way to the specimen. Small steps in the surface result in different optical paths (High resolution topographic contrast).

Polarized Light - The PL technique is suitable for the examination of materials with birefringent phases that alter the polarization state of the light during the reflection process, such as certain minerals (Structural contrast).

4.4.2.9 Fourier Transform Infrared (FTIR) Spectroscopy

Infrared spectroscopy is a technique based on the vibrations of the atoms of a molecule. An infrared spectrum is commonly obtained by passing infrared radiation through a sample and determining what fraction of the incident radiation is absorbed at a particular energy. The energy at which any peak in an absorption spectrum appears corresponds to the frequency of a vibration of a part of a sample molecule.

The interactions of infrared radiation with matter may be understood in terms of changes in molecular dipoles associated with vibrations and rotations. The atoms in the molecules can also move relative to one other, that is, bond lengths can vary or one atom can move out of its present plane. This is a description of stretching and bending movements that are collectively referred to as vibrations.

Molecular vibrations absorb a specific wavelength of the incident radiation. This allows obtaining a plot of absorbance as a function of wavelength. Any molecule has a characteristic IR spectrum, which permits to detect the presence of a given substance within the sample. Anyway, if the materials involved are fragile and hygroscopic, the quality and the reproducibility of measurements can be adversely affected. The technique of Attenuated Total Reflectance (ATR) addresses these issues. The ATR-FTIR spectroscopy utilizes the phenomenon of total internal reflection (Figure 45).

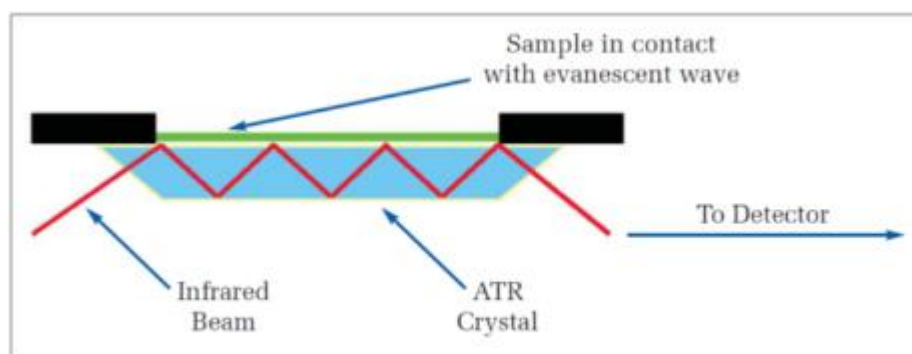

Figure 45: ATR principles

This reflection forms an evanescent wave which extends into the sample. The penetration depth into the sample is typically between 0.5 and 2 micrometres, with the exact value being determined by the wavelength of light. The resultant attenuated radiation is measured and plotted as a function of wavelength by the spectrometer and gives rise to the absorption spectral characteristics of the sample.



Thermo Nicolet 6700 FTIR spectroscope allows the determination of the molecular groups of all organic materials, and many inorganic materials (Figure 46). It works in transmission mode or reflection mode. Spectral range: 350 - 7400 cm^{-1} .

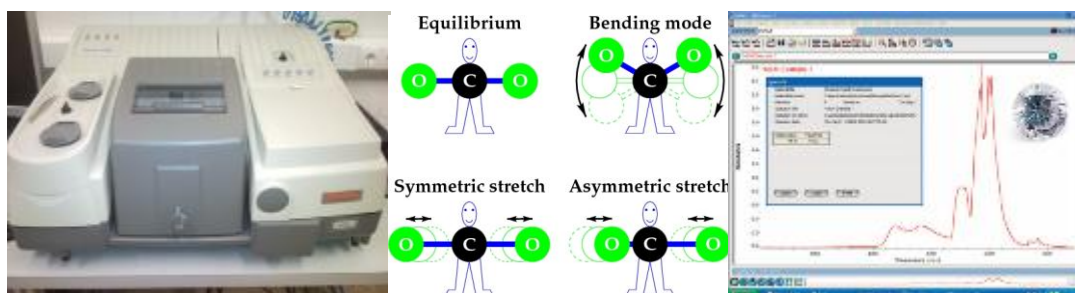

Figure 46: Thermo Nicolet FTIR apparatus and spectrum showing different bonding results

Applications and contribution to HERACLES

Thermo Nicolet FT-IR 6700 spectrometer has a range of step-scan operation modes for time-resolved, phase-resolved and space-resolved experiments, and dual-channel continuous scan mode for polarization modulation/demodulation experiments, as well as conventional single-channel continuous-scan operation for conventional applications.

FTIR is a characterization technique of added value to HERACLES samples from the test-beds, since it helps in the identification of the nature of compounds and detects the presence of eventual organic compounds. The small amount of sample and its high spatial resolution allows for the identification of micrometric mixtures of compounds that constitute the samples, the determination of minor and trace compounds resulting from reactions and weathering and degradation phenomena along with the characterization of existing restoration works.

As an example of application in the field of CH, and related to topics related to HERACLES activities, in Figure 47 is shown a FT-IR spectra acquired on clays of different geological origin (Gubbio and Deruta), showing different profiles [15]

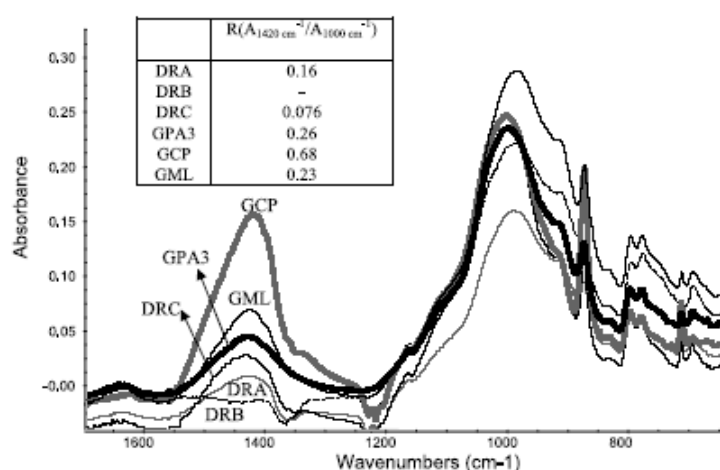

Figure 47: FT-IR spectra acquired on clays from Gubbio (GPA3, GCP and GML) and Deruta (DRA, DRB and DRC); in the insert, the ratio R between carbonate and silicate components, calculated taking into account the absorbance of these two species, is reported [15].



4.4.2.10 Ellipsometry

The principle

The combination of two linearly polarized light beams (one vertically and the other horizontally), which are in phase, results in a linearly polarized light beam. The combination of two linearly polarized light beams (one vertically and the other horizontally), which are not in phase, results in an elliptically polarized light beam.

Spectroscopic Ellipsometry provides accurate measurements of materials optical and structural properties

Applications and contribution to HERACLES

Materials that can be studied: Glass, coated glass; Metals; Semiconductor and Dielectric materials; Laser mirrors; Multilayer optical coatings; Optical antireflection coatings; Electro-optical materials; Computer disks;

What can be determined: Indices of refraction; Extinction coefficients; Multiple Layer Thicknesses; Area mapping; Surface chemistry features; Constituent and void fractions; Surface and interfacial roughness; Alloy ratios; surface temperature (Figure 48).



Figure 48: Jobin Yvon ellipsometer and example of surface layer mapping of silicon over insulator and determination of a multi-layer structure.

Spectroscopic ellipsometry will aid in the optical characterization of materials for cultural heritage applications, namely the restoration materials already applied in comparison with the original ones and the optical behaviour of original and weathered materials from built heritage of the test-beds.

4.4.2.11 Atomic Force Microscopy (AFM)

The principle

Atomic force microscopy, or AFM, is a high resolution imaging technique that can, under some conditions, achieve atomic resolution. With a principle different from many other microscope techniques, in AFM, a nanometric probe is approached to a surface and used to scan it. The position of the probe is monitored by using a detection system (commonly, a beam of light reflected by the probe to a position sensitive photodiode) and forwarded to a feedback system, which can raise or lower the probe in order to assure that the distance probe-sample is constant. Each time the probe encounters an obstacle – a change in topography – its behaviour or position is affected, and the AFM will record that change, allowing to map a surface. In fact, the majority of AFMs function in a ‘tapping’ mode, a mode in which the probe, instead of being deflected against a surface, is oscillated above it, with the alterations in the oscillation generated by the surface, helping to create surface images of an object of study (Figure 49).



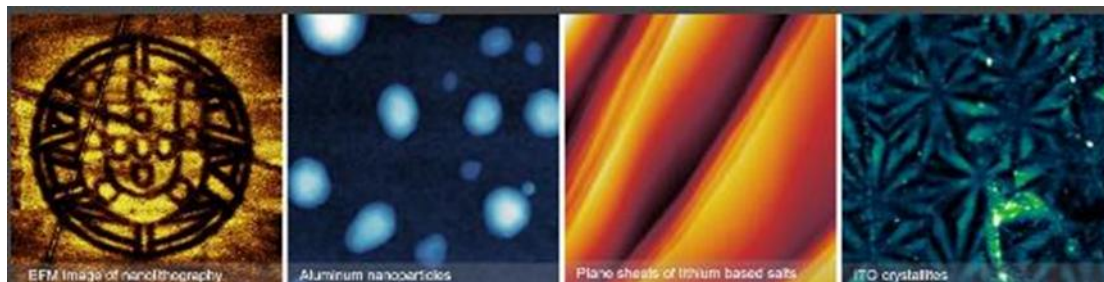

Figure 49: Examples of AFM imaging of nanolithography, nanoparticles lithium and ITO crystals

Applications and contribution to HERACLES

AFM's unique way to interact with the sample opens doors to types of data that cannot be acquired with other microscopes. For example, it is possible to apply a bias between tip and sample and map the conductivity together with topography. At the same time the oscillation of the probe can be used to map the topography, and it can be used to detect electrostatic or magnetic phenomena. The probe can also be used to study properties of the sample, by studying its behaviour when the probe approaches or contacts against it (surface properties like Young modulus, adhesion, long range forces). From point to point a 3D image is generated for morphological, structural, mechanical and electrical sample study. Z-axis picometre resolution sensors allow for precise topography acquisition and roughness analysis. Few to none sample preparation coupled with no need for controlled conditions means that virtually any sample can be imaged with AFM – including biologic elements in liquid media.

AFM is mainly used in surface characterization and can be used in ageing, conservation and cleaning effects studies on cultural materials surfaces for the assessment of coatings and protective layers behaviour and measurement of the size of aggregates. It allows the characterization of the surface of samples taken from the site, showing possible degradation states useful for the study of the degradation mechanisms.

Furthermore, as an example of useful information that this technique can provide on samples of interest for HERACLES studies, in Figure 50 are shown AFM images of the surface of a Candoglia marble non-treated and after treatment with different protective coatings. A comparative analysis was made to estimate the effectiveness of the treatment from a qualitative (images) and quantitative (roughness data, and their statistical processing) point of view. [14]

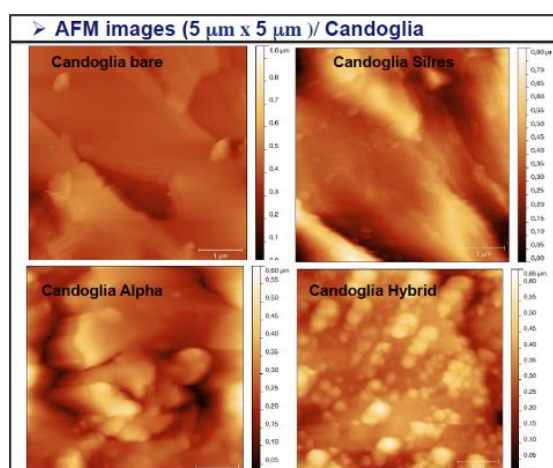

Figure 50: AFM images of *Candoglia* marble surfaces treated with different protective coatings [14]



4.4.2.12 Ultraviolet–visible–Near-infrared (UV-Vis-NIR) spectroscopy

The principle

Spectrophotometry measures the reflection or absorbance characteristics of a sample. The existing equipments have a double-beam, direct ratio measuring system providing solutions in the analysis of films, powders, coatings, plastics and liquids.

The Shimadzu spectrophotometer (Figure 51 left) contains two sets of three gratings to cover the wide wavelength range from the ultraviolet to the near-infrared. This gives a relatively constant energy and signal-to-noise. Data are acquired through three basic modes: wavelength scanning, quantitative, and time scanning, with the software allowing control of all acquisition parameters and storage formats. Post analysis treatments include arithmetic manipulation and transformation of data.

The Perkin Elmer spectrophotometer (Figure 51 right) is a UV/VIS/NIR high-performance double-beam dual monochromator spectrometer with microcomputer electronics. Its wavelength range extends from 3300 to 175nm.

Applications and contribution to HERACLES

UV-vis-NIR spectrophotometry is becoming a widely used characterization technique for cultural heritage materials, since it is specifically interesting for the identification of pigments (namely blue, green, white and red), organic binders, varnishes, degradation of organic or polymeric materials. This technique will aid in the characterization of building materials of the test-beds.



Figure 51: (left) Shimadzu spectrophotometer and (right) Perkin Elmer spectrometer.

4.4.2.13 Porosimetry (Archimedes) and helium picnometry

The Principle

Porosity and density are physical properties of relevance in the characterization of materials and in particular of built cultural heritage produced from powders. The density can be determined by the quantity of matter (mass) corresponding to a given volume. It is of consequence that these volumes usually measured include also the empty spaces existing between particles (pores). In fact, the difficulty associated with the determination of the real volume usually leads to the fact that the apparent specific mass is more currently used. The porosity is thus defined by the ratio of the volume of empty spaces (pores) and the total volume (solid material and empty spaces). From the point of view of materials the porosity is of a great importance since it is directly related to the behaviour of materials (for instance, for ceramic materials, the higher the density the higher the mechanical resistance).

The presence of pores in ancient building materials can have a heavy influence on their life. Likewise, materials used for their restoration are influenced by the porosity. Generally speaking, the pores



worsen the mechanical properties of materials by acting as stress concentration points in which cracks may occur.

Moreover, porosity can promote the capillary condensation of moisture that may solubilize some mortar components or break up the stone by freeze thaw cycle.

Mercury porosimetry is the characterization technique for porous materials. The technique consist of the intrusion of mercury at high pressure into a sample of the material. The pore size can be determined on the base of the applied pressure needed to force the liquid into the pores against the opposing force of the liquid surface tension.

Assuming the pore geometry as cylindrical, the Young-Laplace equation, usually referred to as the Washburn equation, relates the pressure difference across mercury interface (ΔP) to the corresponding pore size (r_{pore}) using the surface tension of mercury (γ) and the contact angle (θ) between the solid and mercury.

$$\Delta P = 2\gamma \cos\theta / r_{\text{pore}}$$

Pores between about 500 μm and 3.5 nm can be investigated

The determination of the density of a solid (even if it is porous) by a Helium pycnometer (Figure 52) gives the real volume by variation of the pressure of a gas in a chamber of known volume. Helium is the gas used, due to its capacity of easily penetrating in all pores and being inert. The pycnometer is made of two connecting chambers of known volume. One is for the sample and the other is an expansion chamber, connected by a valve. The principal advantage of this method resides in its ability to measure only the volume of the solid substance (not considering the pores in the result).

The density is thus given by the ratio of the measured volume and the weight of the sample.

Contribution to HERACLES

The determination of porosity and density of materials from the test-beds will allow for a correlation in materials used in the different monuments, in terms of building techniques, their performances and state of conservation.



Figure 52: AccuPyc 1330 Helium pycnometer

4.4.2.14 X-ray photoelectron spectroscopy (XPS)

X-ray photoelectron spectroscopy (XPS) is a technique for analyzing the surface chemistry of a material. XPS can measure the elemental composition, empirical formula, chemical state and electronic state of the elements within a material. As shown in Figure 53 (left), XPS spectra are obtained by irradiating a solid surface with a beam of X-rays while simultaneously measuring the kinetic energy of the electrons that are emitted from the top 1-10 nm of the material being analyzed. A photoelectron spectrum is recorded by counting ejected electrons over a range of electron kinetic



energies. Peaks in the spectrum are related to the atoms emitting electrons of a particular characteristic energy, as shown in Figure 53.

XPS sampling volume extends from the surface to a depth of approximately 5 - 10 nm. Alternatively, XPS can be used in combination with sputter depth profiling to characterize thin films and coatings by quantifying the distribution of chemical species in depth. XPS as analytical technique is unique in providing chemical state information of the detected elements. XPS can be used to analyse the surface chemistry of a material and is routinely used to analyse a wide range of materials from inorganic compounds, glasses, ceramics, stones, etc.

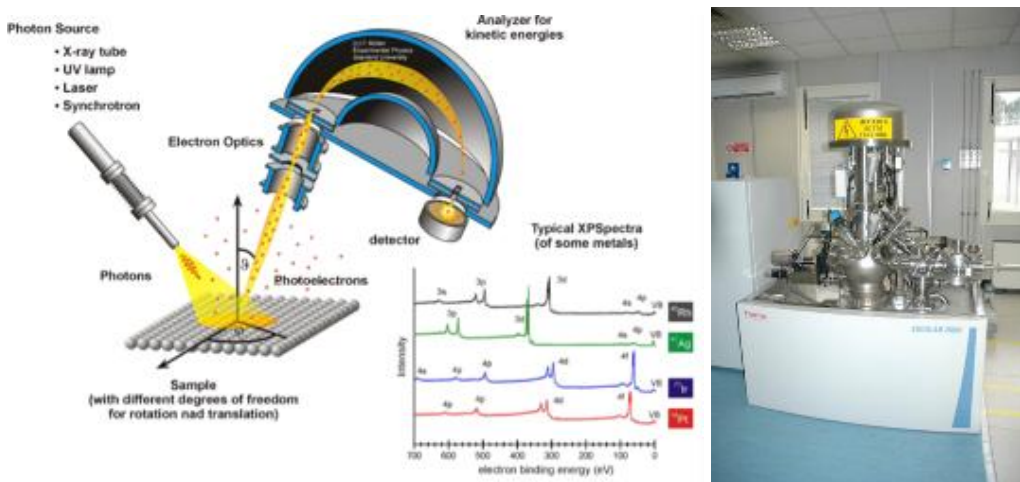

Figure 53: (left) X-ray Photoelectron Spectroscopy experiment and spectra; (right) Escalab 250Xi

The Thermo Scientific ESCALAB 250Xi, (Figure 53 right) is a high-performance, imaging XPS system, capable of multitechnique analysis and which, optionally, has an extensive and versatile range of optional sample preparation facilities.

XPS is a unique analytical technique in providing chemical state information of the detected elements. XPS can be used to analyse the surface chemistry of a material and is routinely used to analyze a wide range of materials from inorganic compounds, glasses, ceramics, stones, etc. In HERACLES it can be particularly useful in characterizing the surface chemistry and gain useful information on the degradation mechanisms studies.

As an example of XPS applicability to CH field and stones in particular, in Figure 54 are shown the XPS spectra of bear *Angera* marble, of the resins and of the marble surface covered with the resin [14].

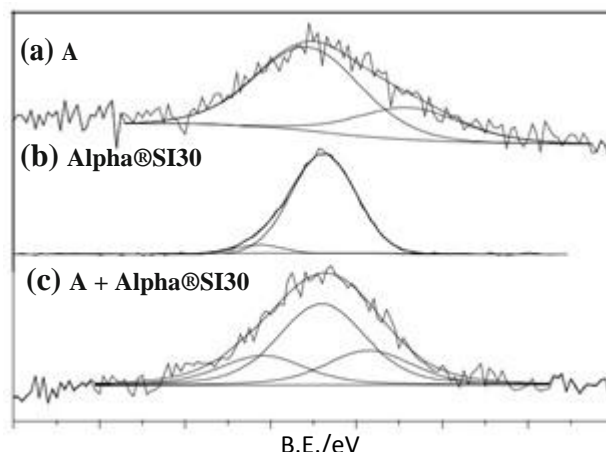

Figure 54: Si 2p XPS spectra of (a) the bare *Angera* stone, (b) the resin Alpha SI30 deposited on a gold foil and (c) the *Angera* stone coated by Alpha SI30 [14]

As well, the results can be treated in order to evaluate which kind of coating produces the best results (Figure 55),

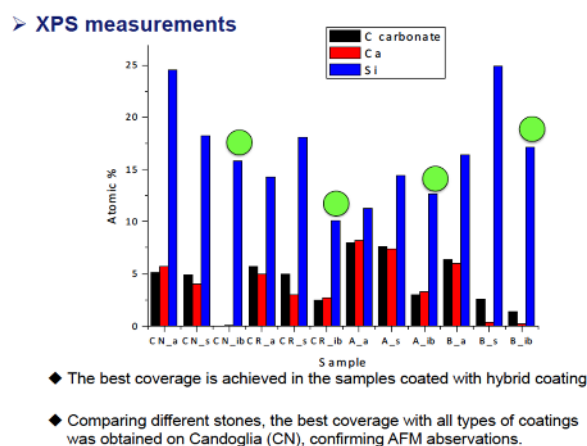

Figure 55: treated XPS data on elemental chemical coverage distribution

and it is also possible to obtain surface maps of chemical element distributions, too (Figure 56) [14]

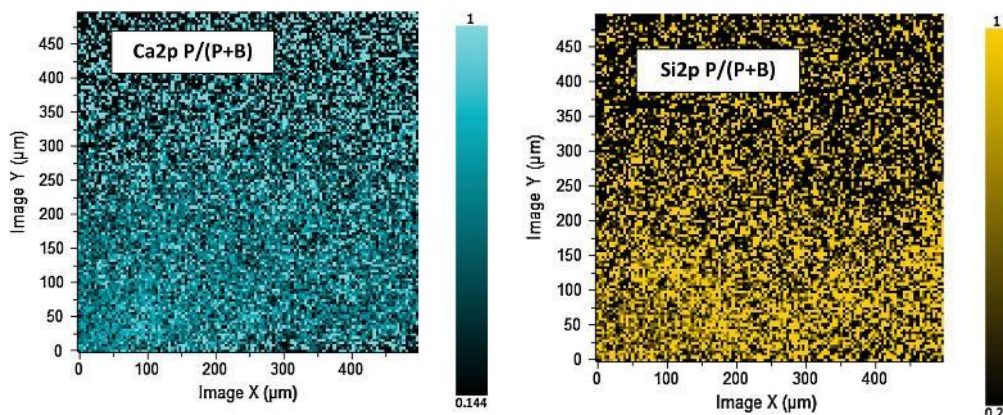

Figure 56: XPS imaging acquired on Botticino limestone: Calcium (Ca) and Silicon (Si) surface distributions [14].





4.4.2.15 Non-linear microscopy

Non-linear imaging is a type of laser scanning microscopy. Tightly focused femtosecond laser pulses represent ideal sources for non-linear microscopy applications. Non-linear image contrast modalities (Multi Photon Excitation Fluorescence (MPEF), Second and Third Harmonic Generation (SHG, and THG)) are well established techniques for biological research. Recently, they have been used as high resolution, non-destructive diagnostic tools for the exact thickness determination and compositional identification as a function of thickness of various CH materials/objects. Specifically, recent works have demonstrated the potential of these techniques for depth resolved imaging of materials such as fresh and aged varnishes, lining glues, historical coatings, parchments, paint and corrosion layer in metal-based artefacts [17, 18, 19].

The lateral and axial resolutions are ~ 750 nm and ~ 2 μ m respectively, while the penetration depth is in the order of 500 μ m for transparent samples.

In the framework of HERACLES project, multi-layer model mineral gypsum samples will be tested. A custom made workstation that combines three non-linear imaging modalities (MPEF-SHG-THG) in a single instrument will be employed. The apparatus consists of an upright microscope and a femtosecond laser source (1028nm, 200fs). The thickness discrimination between the different layers of these multi-layer structures at microscopic level will be investigated via the realization of the non-linear measurements.

4.4.2.16 Analyses/techniques concerning the mechanical, thermo-physical characterization of concrete, mortars, binders and stones

The following analyses/techniques concern the mechanical, thermo-physical characterization of concrete, mortars, binders and stones:

Rheology

The rheology is the science of the flow and deformation of materials and is concerned with the interactions between shear stresses, shear strains and time. The mortars used for restoration and consolidation of ancient masonry must provide an adequate penetration depth and compatibility with the stone or better, a proper plasticity. Moreover, the performance, in terms of plasticity and workability, of mortars of a given composition and morphology are greatly influenced by their rheological behaviour. Typical Shear stress data are shown in Figure 57.

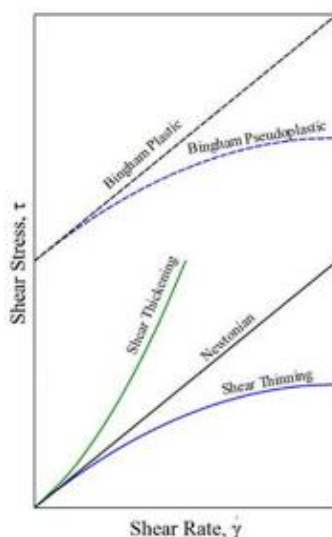

Figure 57: Shear stress as a function of shear rate for several kinds of fluids



For a Newtonian liquid, such as water or oil, the relationship between shear stress τ and shear rate $\dot{\gamma}$ (velocity gradient within the flowing material) is:

$$\tau = \eta \dot{\gamma} \quad (1)$$

where η is the viscosity. In this case, because the relationship is a straight line passing through the origin of the graph and the viscosity is constant, a single measurement of shear stress at one shear rate is sufficient to characterize the liquid.

Other liquids show more complex behaviour and are referred to as non-Newtonian or pseudoplastic liquids. Pseudoplastic liquids conform to the relationship:

$$\tau = A \dot{\gamma}^n \quad (2)$$

where $n < 1$ gives shear thinning behaviour (viscosity decreases with shear rate) and $n > 1$ gives shear thickening (viscosity increases with shear rate) and the viscosity is not constant.

The rheology of fresh mortar normally conforms to Bingham plastic model:

$$\tau = \tau_0 + \mu \dot{\gamma} \quad (3)$$

where τ_0 is the yield stress and μ the plastic viscosity.

Rheometers may induce flow in liquid with two parallel plates where one of the two is stationary and the other rotates with the sample placed within the gap of the parallel-plate sensor system (Figure 58).

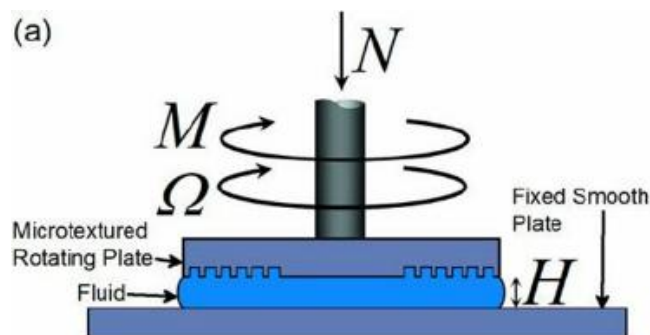

Figure 58: The parallel disk rheometer.

Drilling Resistance Measurements System (DRMS): This is an automatic machine for measuring the drilling resistance of stones, mortars and other materials of similar properties. The drilling resistance is evaluated continuously by the measurement of the drilling force versus depth through a load cell. The instrument has the following main key features:

- Rotational speed 20-900 RPM
- Penetration rate 5-80 mm/min
- Depth of penetration up to 100mm
- Drill bit diameter range 3-10mm
- Depth resolution 50 microns
- Force range 0-100Nt

By means of this method, the evaluation of the surface degradation in terms of depth (μm) and penetration resistance (Nt) will be achieved, thus providing crucial information regarding the several parameters affecting the monument: different environmental conditions in respect to the position of a stone in the monument, different lithological characteristics etc. Regarding performance evaluation of consolidants, in general this can be achieved by the application of several techniques both on



microscopic (i.e. spectroscopic analyses) as well as on a macroscopic level (uniaxial compressive strength). One of the main advantages of DRMS is the fact that it can act as a bridge on a mesoscopic level. Moreover it is the only analytical technique that can provide information about the mechanical properties of the tested material, before and after consolidation, on site, eliminating the need for extensive sampling and sample preparation.

Compression test: For mortars, the tests are performed on 2-in. cube specimens by use of a hydraulic testing machine with load increments up to the achievement of the maximum strength of the material. As it concerns concrete materials, the specimens have dimensions of 10 or 15 cm.

Flexural test: The specimens for flexural tests on mortars are prisms with a square section of 4 cm of side, and a length of 16 cm. The concrete samples have square section with a side of 10/15cm and have length of 50/60 cm. The tests are carried on by use of a hydraulic testing machine, with increasing loads with a constant speed up to the formation of the first fracture. The setup is that of the three point bending flexural test.

Determination of Elastic Moduli: The elastic modulus and the bending modulus are obtained from compressive and flexural tests, respectively, following specific load histories.

Determination of stress-strain curves: The complete stress-strain curves are obtained through an axial test carried on with displacement control. The shape of the specimens is that of the samples for compressive tests. Tests under controlled displacement allow to measure the post-peak unstable branch in the stress-strain plane.

Tensile test: The tensile resistance of the composite is obtained in an indirect way, by split-tensile tests on cylinders of diameter of 10 cm and height of 20 cm.

Ductility test: The study of the ductility of cementitious and composite materials can be investigated through the determination of their behaviour after the peak strength value which determines the maximum resistance of the materials. The post-peak curve is obtained through compressive tests with displacement control on samples with the same shape of those realized for compressive tests.

Dynamic Mechanical Analyzer: the mortars used for ancient masonry should have a Coefficient of Thermal Expansion (CTE) closer as possible to that of stone and thus reducing the risk of cracking during seasonal thermal cycles. CTE can be measured by a Dynamic Mechanical Analyzer (DMA). DMA applies a sinusoidal force and measures sample response at a given temperature. Sample deformation is related to its stiffness. A force motor is used to generate the sinusoidal wave and this is transmitted to the sample via a drive shaft. A Linear Variable Differential Transformer (LVDT) measures the sample response to the applied force. A typical schematic of a DMA instrument is shown in Figure 59.

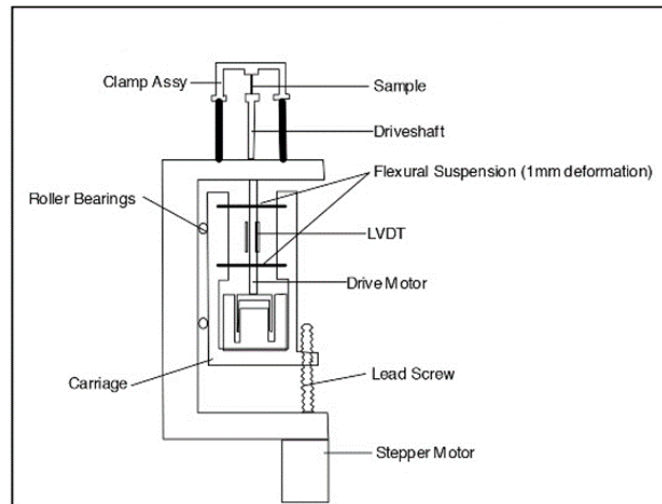

Figure 59: General schematic of a DMA instrument

Slump/flow tests for workability: It is performed on fresh concrete or composites by use of Abrams' cone. The cone is filled with fresh material and then the mould is lifted vertically. The test measures consistency of composites through the measurement of the subsidence (slump) or of the maximum diameter of the expansion of the material.

Water/capillary absorptions: They are performed on cylinders or prisms with small sections, by a gravimetric method.

Density: It is obtained through precise measurements of the volume of the samples and of their weight, by use of measurement devices of high accuracy. The samples are cubes with sides of 2 inches.

Hardness: The determination is obtained through the correlation of the hardness with a rebound number of hardened concrete using a spring-driven steel hammer.

Electrical tests: The tests are performed on cubic samples with 51 cm of side, instrumented with 4 embedded electrodes. A stabilized tension or current is applied. The measurements are carried out with 2-probe and 4-probe methods. Current, voltage or resistance are measured by use of a high precision multimeter.

Hot-disk test: this test is carried on by means of a Hot Disk 2500S apparatus, according to the Transient Plane Source Method (described in the SS-EN ISO 22007-2:2015 standard) and allows to determine the thermal conductivity, diffusivity and specific heat of the samples by means of a single measurement in transient conditions. The measurement is relatively quick, can be performed on bulk and thin film specimens and on samples of different dimensions (even reaching the nanoscale). It can be used to obtain an overall thermal characterization of most building materials.

Hot-plate test: this test allows to determine the thermal conductivity of a 50x50 cm square sample by means of a stationary method. It is carried on by means of a single sided guarded hot plate, according to the ISO 8302, EN 12664 and EN 12667 standards. Such procedure is relatively longer with respect to that of the Hot Disk, but can produce a more accurate λ value.

Hot-box test: this measurement is used to determine the thermal transmittance conductivity of large scale samples according to the ISO 12567-1:2010 and ISO 12567-2:2005 standards. It is particularly useful when a specific wall stratigraphy needs to be tested and fully characterized from a thermal point of view.



Environmental climatic chamber test: this test allows to perform fully controlled transient analyses within the 601×810×694 mm³ test compartment of an ATT DM340SR climatic chamber. Such chamber can guarantee a temperature- and humidity-controlled environment in the range -40÷180°C ±1°C and 10÷98% ±3% of RH and is also equipped with a solar simulator, which can be used to reproduce specific irradiance profiles.

Solar Spechtrophotometer test: this test allows to measure the solar reflectance of surfaces. The equipment is solar reflectometer with an integrated sphere able to measure solar total, diffuse and specular reflectance and transmittance of a 10x10 cm sample in the wave length of 290÷2500 nm, according to the procedure described in the ASTM E903.

Thermal emissometer test: this test is used to characterize the thermal emittance properties of surfaces. The equipment used is a portable thermal emissometer and the measurement procedure is described in the ASTM C1371.

Acoustic transmission loss test: this test is performed by means of a Brüel & Kjær impedance tube and according to the Two Load Method. It allows to characterize the acoustic insulation capability of properly shaped samples, i.e. cylinders with a diameter of 10 and 2.9 cm, or incoherent materials in the range 100÷6400 Hz.

Acoustic absorption test: this measurement is performed by means of a Brüel & Kjær impedance tube and according to the ISO 10534-2 standard. It allows to identify the acoustic absorption performance of both incoherent materials and specifically

Test-room Lab test: this test allows the analysis of the thermal-energy performance of materials (previously characterized in-laboratory) when applied on real-scale prototype buildings. Such test is performed by means of two completely instrumented test-room buildings (3x3x3m) equipped with both indoor and outdoor microclimate monitoring sensors able to continuously collect the following parameters: indoor air temperature, external and internal walls' and roof surface temperatures, mean radiant temperature, relative humidity, and roof albedo.



5 Definition of the systematic protocol

The overall holistic approach towards a systematic sensing, diagnostic and analytical strategy for the different test-beds of HERACLES is outlined in the following schematic Figure 60.

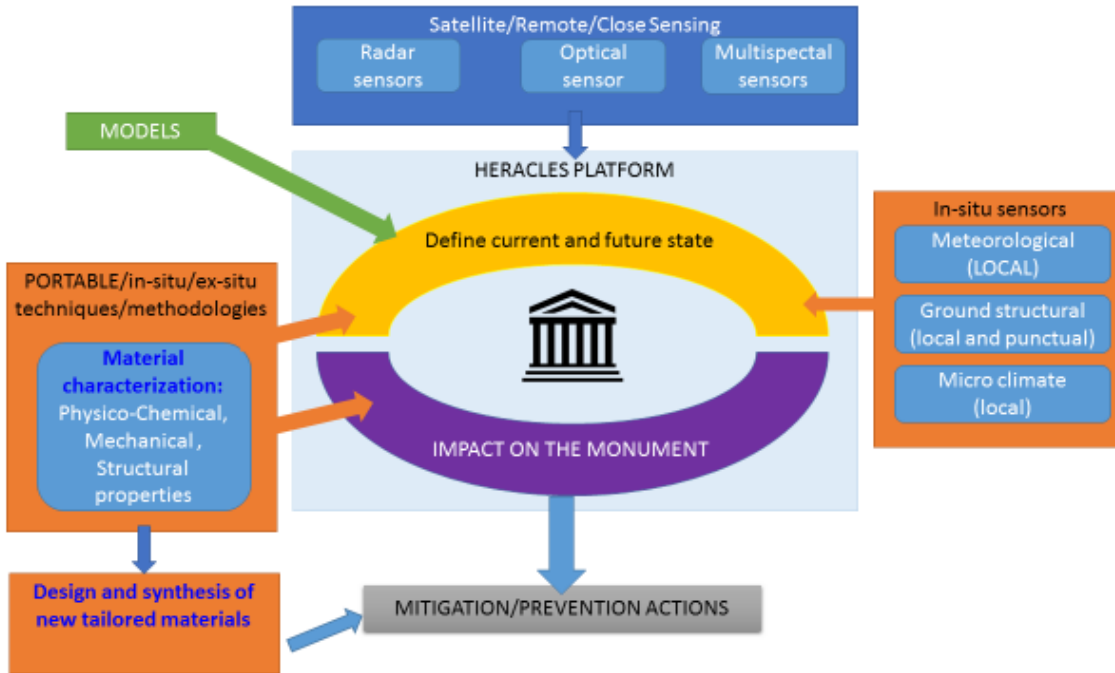

Figure 60: Schematic representation of the HERACLES general protocols approach as regards the sensing, diagnostic and analytical strategies.

For assessing and facing the different risks (defined in the HERACLES deliverable D1.2), for evaluating the climate change impact and risks and for analyzing the related vulnerability (D1.3), each test-bed will take advantage of a multi-scalar strategy. This strategy exploits sensors and techniques/methodologies which examine the CH assets in terms of the surrounding areas, as well as the building structures and their constituting materials. This is carried on by means of satellites and airborne sensors (more detailed described in D3.3), in-situ sensors (accurately described in D3.4) and material characterization methods (more detailed described in D3.5).

Several sensors (satellite, airborne and in-situ) are employed to assess the risk context, the structural state and the environmental factors affecting the test-beds. These sensors acquire information on the structural and environmental conditions around the monument, which are input to the platform in connection with the activities of WP5 and WP6, as well as to the models developed in parallel in WP2.

At the same time, specific information on the physico-chemical properties of the involved materials are acquired through a number of portable (in-situ) and laboratory analytical techniques (ex-situ). The protocol for the use of portable sensor and in-situ analytical techniques is more detailed described in the deliverable D3.2.

The protocols concerning a systematic sensing, diagnostic and analytical strategy of the HERACLES project are developed on the basis of the following critical issues:

- a. **structural condition of the monument/structure**, which refers to the structural issues/criticalities of the monument/assets as a consequence of the identified hazards on site.





b. **material issues**, related to the erosion, weathering and degradation of materials, as defined in D1.2.

First of all, it must be stressed out that the use of a unique and single analytical technique is not sufficient to elucidate the materials status and its degradation mechanism. In fact, each technique provides information only on particular aspects of the object under investigation (i.e: physical, chemical, structural, mechanical, and so on). Furthermore, the effects of the environment, activating new phenomena and reactions, lead to a more complex chemical matrix to be analysed. In such situations, the multi-analytical approach, i.e. the use of several analytical techniques, is essential [20]. The overall HERACLES multi-disciplinary and multi analytical approach is visualized in Figure 61, where the details of the general concept for the protocols to use are shown.

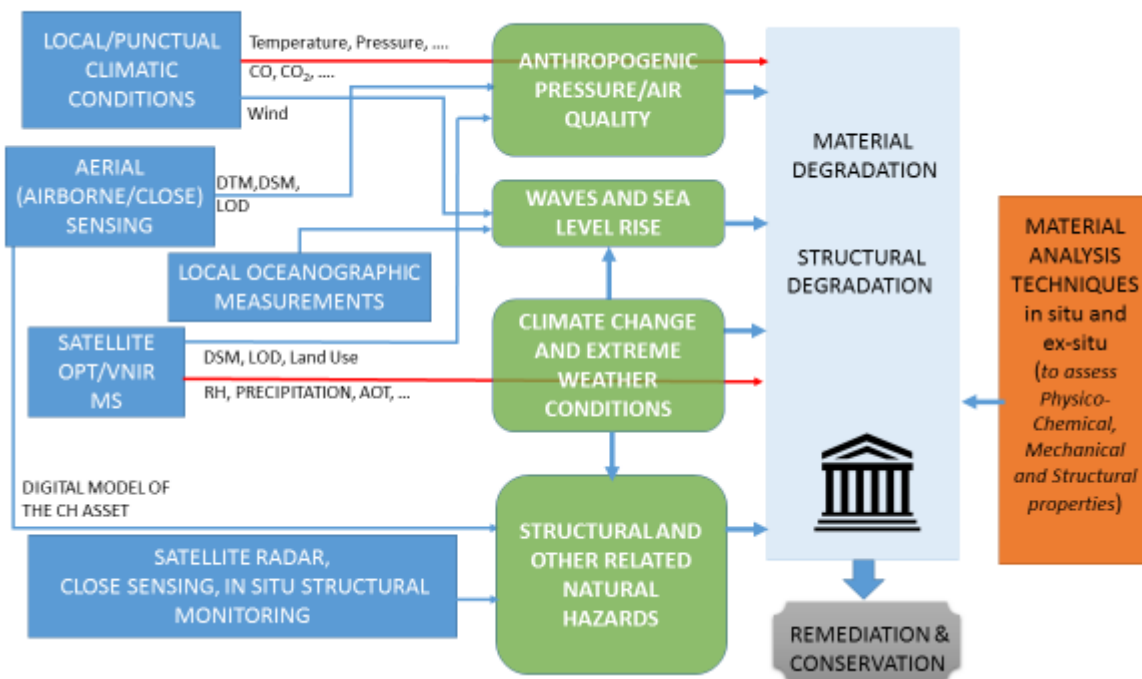

Figure 61: Outline of the HERACLES general protocols approach as regards the specific critical issues already discussed in the document.

The overall purpose is to perform a context and site analysis together with risk assessment of the CH asset to support the mitigation actions definitions aimed at contrasting the effect of weathering, erosion, materials and structures degradations associated with climate change in conjunction with natural and anthropic hazard. The above **general scheme** will be tailored for the specific site needs, as discussed in the following sections dedicated to this purpose, according to the priorities defined by the end-user requirements (D1.2).

In Figure 61, the sensor measurements are represented with the blue colour blocks, on the left. Acquired sensor data are, in most of the cases (blue arrows), input for the models, represented with green blocks, in the middle part of the image, allowing the definition of context and site analysis, as well qualitative risk assessment. This assessment, addressed in a multi-risk scenario as highlighted in D1.3, is supported by the material analysis techniques (orange block), and leads to the overall evaluation of the hazard effects on the CH asset (light blue block), thus providing useful indications for the definition of mitigation and conservation actions (grey block).



More specifically, the protocol involves a holistic, multisource/multiscale sensing and analytical tools, which include remote and in-situ sensing able to gather wide area and very detailed information about the sites of interest and the context where they are located, as well as subsurface measurement, integrated by local monitoring sensors and complemented by techniques and methodologies for chemical, mechanical and thermo-physical material characterization. Such a tool is aimed at the final goal of investigating the structural and material degradation induced by the natural and anthropic hazards affecting the CH assets associated with the environmental factors. For the HERACLES test-beds risks, as defined in D1.2, these factors related to the climate change, include extreme weather conditions and pollution factors.

Meteorological factors concur in the weathering, erosion and generally in material degradation. Long term scenarios (on time scales of some decades) for climate change and extreme weather modelling are the subject of activities in WP2. From the point of view of the sensors, the analysis is supported, as shown in Figure 61, by a multi-source, multi-scalar measurement approach. Specifically, multispectral (MS) satellite sensors are considered for their capability to provide information (also historical) about meteorological parameters, e.g., relative humidity (RH), precipitation etc. The measured parameters are exploited in parallel to measurements collected by local meteorological stations. The latter provides direct “ground truth” on environmental factors which complements the output of long term modelling: such data are useful for the assessment of the local current climatic condition which impact on material degradation (see the red lines in Figure 61).

In the protocol are also considered the weathering phenomena affecting the test-beds due to pollution factors, which are again the subject of activities carried on in WP2 regarding the anthropogenic pressure modelling. High resolution Optical/VNIR remote sensing will provide key information for the anthropogenic pressure/air quality modelling. To this aim, land use maps, DSM, DTM and 3D spatial city models (LOD products) extracted from optical/VNIR satellite or, depending on data availability, from airborne photogrammetry, will be used. Also in this case, direct historical and current information of pollution factors, although on a rough spatial scale, will be provided by MS satellite measurements (see Sect.4.1.2). Local microclimate measurements of environmental factors (temperature, atmospheric pressure, solar radiation and pollution) with the light portable system developed by UniPG, are also considered for their capability to provide very high resolution information on the scale of the CH asset.

Coastal risks are considered as hazards affecting monuments located close to the sea. For instance, the involvement of local oceanographic measurements in HERACLES is essential for the hydrodynamic model aimed at the investigation of waves and sea level rise affecting the Koules Fortress.

Finally, concerning the structural health evaluation of CH assets, the protocol involves the use of satellite radar remote sensing technology for wide area surveillance, particularly useful to identify possible hazards from the area (as for instance landslides), as well as in-situ measurements of static and dynamic sensors and subsurface inspection. The integration of close sensing data, providing very detailed information on the scale of the monument (for instance, 3D models) can be exploited to set-up/update numerical structural models of the asset/monument under study: the latter are essential to the assessment of the structural health conditions.

Material analysis techniques, available for a detailed in-situ and ex-situ investigation of the materials chemical, mechanical and thermo-physical properties, provide useful information for the assessment of the current state of the materials weathering which is essential to understand the effect of climate change on the long term. The analysis performed in-situ and ex-situ on the CH asset will provide elements for the evaluation of its conservation status and for the necessary mitigation and remediation actions.





Considering the large number of the materials concerned, the different structural critical issues and the different vulnerability problems due to climate change, the protocols will be carefully fine-tuned for each individual situation. For these reasons, the following suggested protocols are outlined and discussed in this perspective.

OUTLINE OF THE SUGGESTED PROTOCOL

1. Aims of the diagnostic and analytical strategy vs user need

Each protocol, based on the detailed end-user requirements for the HERACLES test-beds as discussed in D1.2, briefly describes the purpose of the diagnostic and analytical strategy and diversifies the procedures that have to be undertaken on the basis of the structural issues of the monument/asset, its construction materials and its weathering state.

2. Selected zones and elements of significance

Selected zones, sections and elements of the monument/asset will be presented and justified.

3. Outline of the sensing, diagnostic and analytical methodologies

To address the issues identified in the D1.2, a number of sensing, diagnostic and analytical procedures are required. This section of the protocol outlines a general schedule of the activities to be undertaken for the purpose of the HERACLES project.



5.1 Gubbio

Gubbio is affected by a multi-risk scenario, particularly referring to the hydrogeological risk and risks related to pollution, sudden temperature changes, weathering and seismic hazard.

Extreme climate events, most in terms of heavy rain and its local effects, are causing structural instabilities for the overall historical area, as testified by the existing and progressive slow deformations and crack patterns affecting the ancient structures.

The CH assets identified in Gubbio are the medieval Walls and the Consoli Palace. The local effects that are causing structural risks can be detected in terms of existing deformations, crack patterns and collapses.

Moreover, the constituent materials are characterized by an ongoing degradation state related to the environmental actions: climate change and pollution. Critical issues are associated mainly with a higher concentration of CO₂, intensification of rainfalls including acid rains. Both are causing stone detachments by dissolution of carbonates and blackening of the surfaces. Extreme rain events, that have characterized the local climate condition of the Gubbio area in the last decade, led to the appearance of moisture and mold on the ancient materials surfaces, and moreover are causing erosion phenomena on mortars, inducing possible structural instabilities.

Finally, a dedicated survey of the two selected case studies, i.e. Consoli Palace and Town Walls, is provided, highlighting the need to monitor the air quality in their proximity, because the environmental pollution is probably linked to the darkening of the building surfaces.

The following sections report some details about the protocol/guidelines for the HERACLES test-beds monitoring in Gubbio.

5.1.1 Town Walls

In this section, issues related to the Town Walls are briefly reminded. The town Walls are on the slopes of the Ingino mountain and for this reason they are particularly affected by the hazards deriving from heavy rains, flood, landslides that would endanger their safeguard. These problems were investigated in detail in D1.2, with particular emphasis to the hydrogeological risk. In Figure 62 a partial view of the Town Walls, against the mountain, is shown.



Figure 62: a partial view of the Gubbio Town Walls on the slopes of the Ingino mountain



5.1.1.1 STRUCTURAL ISSUES

The structural issues concerning the Town Walls will be addressed considering different aspects, as detailed below in the following sub-sections.

5.1.1.1.1 *The aim of the diagnostic and analytical Strategy*

As described in D1.2, several meters of ground material are continuously accumulating against the Walls: at present, the estimated soil accumulation is more than 5-6 m and progressively increases with a rate of around 50 cm/century. Meteorological factors, as torrential rains and humidity, increase the soil “pressure” on the Walls. The local effects are causing structural risks which can be visually detected in terms of existing deformations, crack patterns and collapses.

In particular, the structural behaviour of the Walls is affected by the following main factors: increased torrential rains, humidity affecting the soil and the surrounding natural areas, sediment transport, storm-water runoff, increase of the water level in the underground. All these factors mainly require a mitigation of the hydrogeological risk and studies on the walls structural behaviour.

5.1.1.1.2 *Selected zones and elements of significance*

Figure 63 shows the areas of interest defined together with Gubbio municipality. In the following, the zones will be identified as:

- i. Area 1: in Zone 1 (“*Forte di Parco Ranghiasi*”);
- ii. Area 2: in Zone 2 (“*Cassero*”);
- iii. Area 3: between zone 3 (“*Torre*”) and zone 4 (“*Porta S. Ubaldo*”)
- iv. Area 4: between zone 4 and zone 5 (“*Bughetto*”)

Area 2 was secured several years ago by removing the infill materials on the mount side and building a retaining wall.

Legenda zone :



Figure 63: Areas of interest for the medieval Walls of Gubbio



On the contrary, the Area 1 and Area 3 are currently withstanding the growing soil pressure induced by the backfill. The ongoing accumulation process of the soil against the walls can be deduced by several evidences, as the deformation of the retaining walls, the increasing levels of the accumulated rubbles, etc.

The southern part of Area 3 has been recently restored, both by removing the backfill material and by restoring the structures themselves. Nevertheless, there is a portion of the Walls characterized by an evident out-of-plane rocking process. Therefore, it is mandatory to monitor the status of the walls with emphasis on these selected areas, also where restoration actions were already carried out, to assess the effectiveness of the intervention from a structural stability point of view.

5.1.1.1.3 Outline of the sensing, diagnostic and analytical methodologies

The small scale (i.e. wide area) monitoring approach with satellite radar for all the areas of interest should involve the processing of HR as well as VHR data: both processing techniques available in HERACLES (PSP and TMS) will be used. Specifically, HR data acquired by Sentinel 1, operating at C-Band should be processed via the PSP technique to gather possible information about the hydrogeological risk associated with movements of the landslide pushing against the walls. Criticalities associated with the typology of landslide and the vegetation coverage, which hinders the visibility of the landslide from a radar, are however preliminarily considered.

Although characterized by a lower resolution with respect to the VHR data, the use of radiation at C-Band, acquired from the Sentinel 1 (HR data), results less influenced by the presence of vegetation, and the signal coming from the ground is consequently less perturbed: the landslide (likely debris flow) monitoring is rather challenging for the satellite monitoring. X-Band VHR data will be processed both with the PSP method, as well as with the TMS processing method which is better targeted for reconstructing and monitoring structures developed vertically as the walls.

VHR data are considered with higher priority due to the expected measurement density (coverage) and the direct impact on structural model.

The protocol for the structural monitoring and analysis involves also the use of in-situ ground measurements.

Regarding the Area 2 (*Cassero*) and the surrounding walls, a detailed survey of the critical parts of the walls will be performed. It will concern both the degradation state of the constituting materials and the geometrical considerations useful to estimate the out-of-plane rocking risk. GPR and/or holographic radar systems will be used to perform structural integrity investigations and to gather information about the degradation state of the materials. Moreover, GPR surveys will be performed to investigate ground stratigraphy (layering) and gather data that are useful for the out-of-plane rocking risk estimation. Additionally, stand-alone inclinometer sensors will be installed for static monitoring purposes.

For Area 3 near *Porta S. Ubaldo* an inclinometer sensor will be installed in order to check the actual status of the structure.

Close range laser scanning could provide 3D shape reconstruction extremely useful for structural model. Close sensing will be carried on by drones and/or in-situ, aiming at the fine reconstruction of the CH asset shape.

The hydrogeological risk associated with the landslide requires also sub-surface investigations, which are possible in HERACLES project by performing non-invasive analysis carried on by means of GPR and ERT technologies. These instrumentations will be used to characterize the ground around the walls. In this framework, GPR surveys will provide two dimensional horizontal and vertical transects devoted





to detect possible sub-surface inhomogeneity in terms of dielectric permittivity. Furthermore, ERT, which is a geophysical imaging technique, will provide effective and useful information on the distribution of resistivity contrasts identifying ground features and detecting sliding material and bedrock. The ERT method can, indeed, identify potentially unstable areas.

5.1.1.2 MATERIALS

The atmospheric moisture change is the main hazard affecting the Town Walls since its major consequence are intense rainfalls that leads to flooding. These can affect the masonry itself due to erosion of the mortar or cracking of the system stone/mortar or to an increase of the aquifer levels that leads to a higher pressure on the walls, creating structural instability.

In addition, the combined action of the acid rainfall, the air pollution, the cold and the biological agents, produces a visible material degradation of the outer surface, such as: loss of material (formation of hollows, differential degradation, erosion, gap, lacking, pitting), decay of the material cohesion (disintegration, pulverization), loss of continuity perpendicular or parallel to the outer surface (fracturing/cracking, peeling, warping, swelling, scaling), addition of foreign material (concretion, crust, surface deposit, efflorescence, scaling, stain, film), colour variations (discoloration and patina).

In this section, issues related to the Town Walls constituting materials are described.

5.1.1.2.1 The aim of the diagnostic and analytical strategy

Risks are mainly associated with stone deterioration caused by climate change effects coupled with pollution and degradation of the mortars as binding agents of the walls.

The HERACLES activities for this scenario, will address the quality and the state of the building materials and mortars used and their properties.

In particular, the study of the degradation mechanisms will be carried on through the characterization and study of the degraded materials.

5.1.1.2.2 Selected zones and elements of significance

The Walls areas to focus on are shown in Figure 63 and exhibit several issues related to the different materials degradation (limestones, travertine, sandstone-Serena stone, plasters, binders) used for building and restoring. These materials suffer of increased deterioration due to climate change effects coupled with pollution. The structural material principally used is the limestone extracted from the quarries site in the neighboring mountains in two different extraction periods. The oldest limestone was extracted before XV century and does not exhibit significant criticalities. The second limestone type (extracted after XV century) is affected from a significant degradation with the formation of dark patinas (“Black crusts”) on the surfaces.

Another predominant issue is the gradual degradation of the mortars. This material is very important since the mortar function should make spatially uniform the stresses through the joints between the stones, ensuring in that a way the structural stability. The degradation/reduction of the mortar entails the loss of homogeneous distribution of the stresses on the surface of the stone and leads to a heterogeneous stone-binder system behaviour.

5.1.1.2.3 Outline of the sensing, diagnostic and analytical methodologies

The protocol for the analysis of the Town Walls covers also the aspects related to atmospheric moisture change and intense rainfall.





The monitoring requires the acquisitions of historical and up to date meteorological data (relative humidity, temperature, etc.). Such an information can be obtained by available past acquisitions of multispectral satellite, as well as, by currently operating sensors. Such data can provide valuable information, within the context of a tailored climate change investigation related to long term analysis of risks and extreme events. In particular, the monitoring of precipitation and temperature time series acquired by remote sensing platforms and integrated with local measurements, can be used to develop specific climate change indicators, such as the number of rainy days per year, the amount of rainfall per month, the number of extreme precipitation events that are associated to landslide events. Precipitation data are also commonly used as input to hydrological rainfall–runoff models for future understanding of the behaviour of catchments and landslides. These precipitation measurements with complete spatial coverage have a clear advantage in the fact that they overcome the spatial sampling problems typically associated with gauge networks. An added advantage is that more information on the spatial distribution of precipitation is available. By adopting the same approach, also the temperature recording can be used to develop specific climate change indicators to analyze the thermal stress due to the heat waves, the daily maximum and minimum temperature difference, the days with minimum temperature lower than zero, etc. Satellite and aerial high resolution optical survey will be carried on to collect information useful for the integration of climate analysis regarding pollution and anthropogenic pressure modelling. Stereo/Tri-stereo acquisitions with spaceborne sensors can provide reference ortho-images, as well as very useful information about DTM, information layer on buildings (LOD 1) and land cover. Furthermore, data acquired from airborne platform will be useful to generate higher resolution ortho-photo, as well as DSM and LOD2 product. Space and aerial derived informative layers can be considered as input to the modelling of pollutant deposition carried on in the framework of HERACLES WP2 activities.

A local microclimate monitoring campaign, implementable in HERACLES by CIRIAF-UniPG, in the close proximity of Area 2 and Area 3 of the ancient town walls is necessary in order to investigate the possible correlation between the terrain stack detected behind them and the local climate change phenomena, i.e. heavy rain events, which occurred during the last few years in the city area. To this aim, the main local microclimate parameters (i.e. dry bulb temperature [°C], relative humidity [%], surface temperature [°C], air quality in terms of CO₂, VOC, CO [ppm], wind speed [m/s] and direction [°], etc.) should be collected. Such local microclimate monitoring will be carried on both from the ground (i.e. at pedestrian level) and from the air, for instance by means of drones, in order to be able to assess the materials surface degradation level at different heights. The acquired data can be statistically analyzed and correlated to weather data provided by complete weather stations, positioned in the surrounding area.

Particular attention has to be devoted to the analysis of specific parts of the walls characterized by the advanced superficial degradation of the materials, i.e. black crusts or mold presence, in order to assess its correlation with peculiar climate conditions, such as relative humidity and air quality.

After the preliminary experimental campaign, a calibrated microclimate model of the area of the walls will be elaborated in order to investigate the impacts of local climate events on the materials in terms of air and surface temperature, relative humidity, and air quality. The final aim is to understand the possible microclimate causes of degradation and to propose solutions.

The analytical and diagnostic strategy of the materials will include also techniques for the physical, chemical, morphological, mechanical and thermo-physical characterization of concrete, mortars, binders and stones.

The mechanical and thermo-physical characterization allows to verify the state of the conservation and the resistance to the mechanical and thermal stress of the materials. The techniques involved have been reported and briefly described in Section 4 of this document.





Concerning the physico-chemical and morphological characterization, a multi-analytical approach has to be considered.

Generally, the use of at least one technique for the elemental analysis and a second one for the molecular identification of compounds has been the most usual multi-analytical approach for studying different kinds of degraded materials. The combined use of different spectroscopic and microscopic techniques [FTIR spectroscopy, XRF, XRD, Laser-based spectroscopy (LIBS and Raman), AFM, SEM-EDS and XPS], together with the thermal analysis (DSC and TGA [16], particularly for ancient mortars) is suggested to identify in unambiguous way the composition of the material under analysis.

The combination of different techniques can also be used in the discrimination of original components and decay products from a specific building material and in the identification of decay products on man-made building materials, such as bricks and mortars affected by urban pollution, or historical building materials affected by impacts of acid rains from traffic sources.

5.1.1.3 SYSTEMATIC PROTOCOL RELATED TO THE DIAGNOSTIC AND ANALYTICAL STRATEGIES FOR GUBBIO TOWN WALLS

In the previous paragraphs all the criticalities affecting the Town Walls have been briefly reported, as well the methodologies suitable to study this CH asset.

In the following picture (Figure 64), a summary of the systematic protocol proposed for the Town Walls is presented.

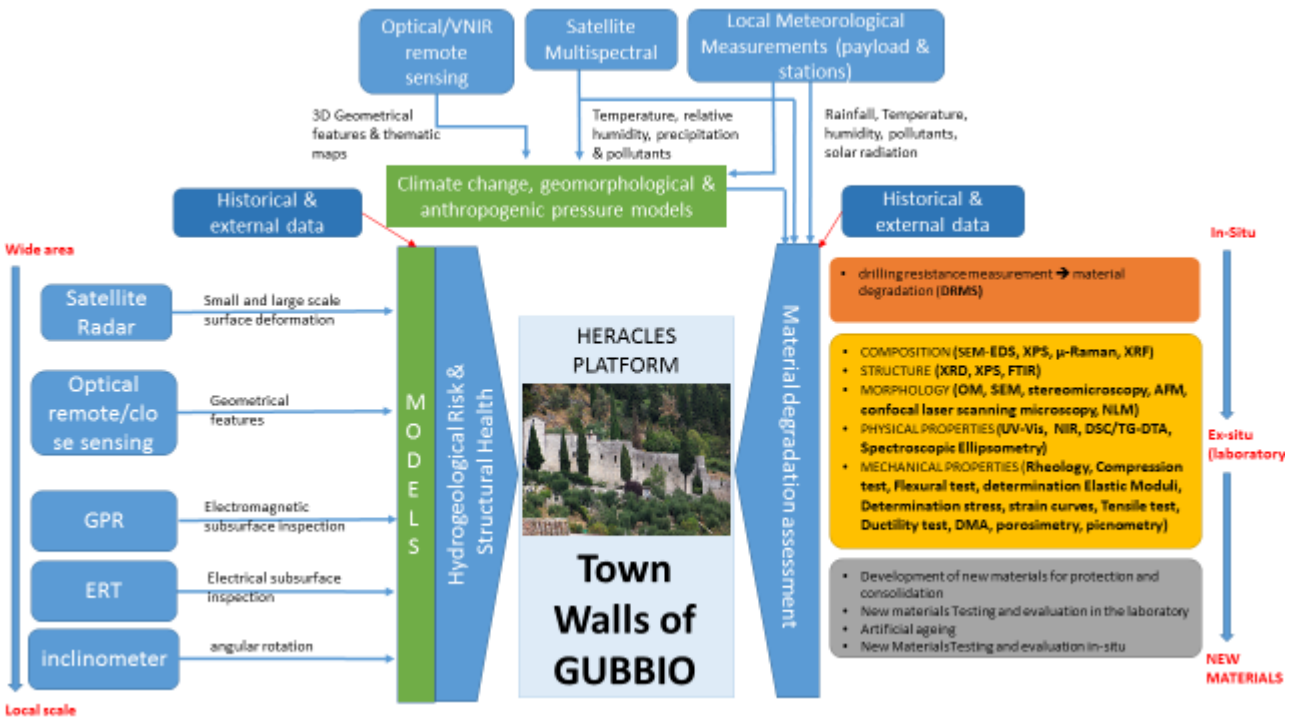

Figure 64: Systematic protocol flow view for Gubbio Town Walls



The aim is to provide a clear and easy visualization of all the phases/actions necessary to assess the current situation of the Town Walls, in this case.

A similar approach will be proposed for all the other HERACLES test-beds, which, of course, will present differences in the risks to assess as well as in the analytical techniques to be used for that purpose, depending on their peculiarities/criticalities.

5.1.2 Consoli Palace

The Consoli Palace is located in the high monumental part of the town and was built on two foundation levels, as it can be seen in Figure 65. Its main entrance is on *Piazza Grande*, a daring pensile square resting on four arches.



Figure 65: a view of Consoli Palace (on the left) and *Piazza Grande*.

In this section, issues related to the Consoli Palace are described.

5.1.2.1 STRUCTURAL ISSUES

The structural issues concerning the Consoli Palace will be addressed considering different aspects, as detailed below in the following sub-sections.

5.1.2.1.1 *The aim of the diagnostic and analytical Strategy*

Consoli Palace, one of the most important symbols of Gubbio monumental part, presents several peculiarities that must be taken into account for its conservation.

From the structural point of view, it should be noted that the construction has the foundations placed at different levels, due to the local topography. This aspect confers to the west side of the structure a remarkable height of about 60 m. The difference in height of the two levels of the foundations is about 30 m and this could lead to significant structural issues in the presence of differential settlements. Actually, the presence of such effects are visible in the west wall and in the cross vaults



of the loggia, under the form of activated local mechanisms and crack patterns. At the top of the structure, in the same side of the palace, a little slender belfry is located. The atmospheric moisture change is a hazard affecting the palace, enhanced by the intense rainfalls that leads to flooding. Furthermore, main risks are linked to variations of the aquifer level that could induce foundation settlement.

5.1.2.1.2 Selected zones and elements of significance

As reported in document D1.2, the main critical aspects are highlighted in the south-west part of the Palace called “loggia” (see Figure 66), where an out-of-plane rocking mechanism is becoming evident by a widespread cracking pattern, and in the west side, in which the external wall has become to detach from the other parts of the building, probably due to the horizontal thrust of the vaults and/or seismic actions.

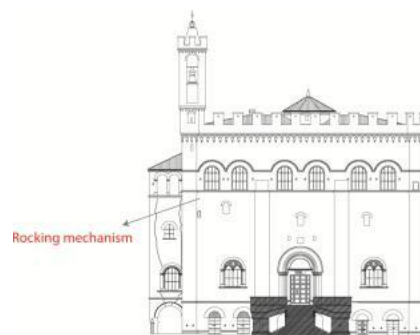

Figure 66: Location of the Rocking mechanism affecting the SW façade

5.1.2.1.3 Outline of the sensing, diagnostic and analytical methodologies

Due to the characteristics of the CH asset of interest, satellite radar approach will involve in this case only the processing of VHR data. X-Band VHR data on ascending and descending passes will be processed with the PSP method to achieve deformation measurements on Consoli Palace and the surrounding elements so to achieve a local monitoring. The application of the TMS processing methods is also considered for its potential capability to provide more clear indication about the deformation of the asset of interest and particularly on its vertical walls. The output provided by the satellite radar sensing is essential in view of the assimilation of SAR data in the structural model for structural health analysis.

As for the Gubbio town walls, the satellite monitoring will be complemented by close sensing methods with laser scanning to acquire detailed 3D reconstruction and point clouds that can be integrated in the structural model.

For the structural health analysis the protocol includes an in-situ monitoring system comprising both static and dynamic sensors. Static sensors, and in particular LVDT can allow measuring the evolution of the crack pattern of the west side of the palace. Dynamic sensors constituted by accelerometers installed within HERACLES activities are continuously recording the vibration of the structure for long-term structural monitoring purposes. This sensing system will be able to track the evolution of structural behaviour during the monitoring period and to reveal possible anomalies.

In-situ measurements will be integrated with the data provided by instrumentation for sub-surface inspections, preferably performed by using non-invasive methods. To pursue this goal, the use of GPR will be useful to carry on structural surveys and foundation inspections devoted to detect anomalies and risk factors arising in the critical areas.



5.1.2.2 MATERIALS

Several restorations were made after the 1982 and 1984 earthquakes and completed in the first half of the '90s. During these restorations, the façades were completely cleaned from the accumulations of dirt. After only twenty years, however, smog, concretions and localized phenomena of black patinas are again clearly visible. Dark patinas are widely visible and well highlighted by the presence of other adjacent stones that are not minimally blackened, even if experiencing the same environmental conditions (Figure 67). A more detailed description was already provided and available in D1.2.



Figure 67: partial view of the Palace façade with the staircase, with evidences of the stones blackening

In this section, issues related to the materials characterising the Consoli Palace are described.

5.1.2.2.1 *The aim of the diagnostic and analytical Strategy*

In the case of Consoli Palace, the HERACLES activities have to face the degradation of materials due to the combined action of meteorological aspects and atmospheric agents. As indicated for the Town Walls, the study of the mechanisms of degradation will be performed through the characterization of the degraded materials.

5.1.2.2.2 *Selected zones and elements of significance*

Similarly to the case of the Town Walls, the main risks is associated to acid rains (pH precipitation) and changes in deposition of pollutants. These can lead to stone erosion by dissolution of carbonates and/or stone blackening, especially affecting limestone.

The masonry itself is affected by loss of material, due to erosion of the mortar or cracking of the system stone/mortar. As previously discussed in section 5.1.1.2.2 “Selected zones and elements of significance” (for the Walls), also here a type of limestone is showing a more significant degradation of the surfaces, and in absence of protection by plasters on the façade, formation of dark patina occurred in a period of time considerably shorter.



5.1.2.2.3 Outline of the sensing, diagnostic and analytical methodologies

The investigation approach is similar to the one chosen for the medieval Walls described in the previous section. It will involve the use of a multiscale sensing and common information sources, especially from satellite and airborne survey, are foreseen.

Therefore, Multispectral (MS) satellite historical data will be used to provide valuable information for a tailored climate change investigation for long term analysis of temperature changes related risks and extreme events. Concerning the climate conditions monitoring, the remote sensing technology can give a relevant support for analyzing the time series of precipitation, temperature and the boundary conditions of air pollution in order to better estimate the causes of well-known effects such as black crusts and surface erosions. The rainfall, the temperature and the relative humidity have a relevant role in enhancing the effect of air pollutants like particulate matter and greenhouse gases on the building surfaces.

Similarly, satellite and aerial high resolution optical survey collected data have to be used for integration of climate analysis regarding pollution and anthropogenic pressure modelling. Space and aerial derived informative layers can provide information also for the modelling of pollutant deposition. The activities about models are object of WP2.

A dedicated microclimate monitoring campaign of the outdoor and indoor area of the Consoli Palace is also planned in order to investigate the local environmental conditions in terms of dry bulb temperature [°C], surface temperature [°C], relative humidity [%], air velocity [m/s], air direction [°], and air quality in terms of pollutants concentration [ppm]. In fact, it is important to assess the correlation between local microclimate parameters and the degradation of the construction materials surface. A physical survey highlighted, already, the local darkening of the material surfaces and sometime also the appearance of molds over the building surfaces.

The monitoring will be performed by means of the same environmental payload equipment used for the Town Walls, for the geo-referenced mapping of the air temperature, relative humidity, air quality, and surface temperature of the area. Additionally, dedicated indoor air temperature sensors will be positioned inside Consoli Palace. They will be useful for the calibration and validation of the building numerical model, which would allow to predict its thermal performance.

Particular attention has to be devoted to the analysis of specific parts of the Palace walls characterized by the advanced superficial degradation of the materials, i.e. black crusts or mold appearance, in order to assess its correlation with peculiar climate conditions, i.e. relative humidity and air quality.

Moreover, historical climate data in the area of Gubbio collected with dedicated meteorological stations, will be used in order to evaluate the possible correlations between such local microclimate parameters measured in the proximity of the Consoli Palace and local weather boundary conditions generating the materials degradation.

As reported before, the diagnostic strategy of the materials will include the use of techniques for physical, chemical, morphological, mineralogical, mechanical and thermo-physical characterization of concrete, mortars, binders and stones. To characterize the impact of atmospheric pollutants it is necessary to collect as much information as possible from different analytical techniques, to obtain a detailed overview of the building conservation state.

The use of all these complementary techniques, will help in evaluating the consequences of possible decay processes, taking into account the individual and synergic impact of different environmental stressors (atmospheric acid pollutants, sunlight, humidity, infiltration waters containing dissolved ions, etc.) on CH materials.





On the basis of this study, conservation and/ or remediation strategies could be designed.

5.1.2.3 SYSTEMATIC PROTOCOL RELATED TO THE DIAGNOSTIC AND ANALYTICAL STRATEGIES FOR GUBBIO – CONSOLI PALACE

In the previous paragraphs all the criticalities affecting the Consoli Palace have been briefly reported, as well as the methodologies suitable to study this CH asset.

In the following picture (Figure 68), a summary of the systematic protocol proposed for the Consoli Palace is presented.

The aim is to provide a clear and easy visualization of all the phases/actions necessary to assess the current situation of the Consoli Palace.

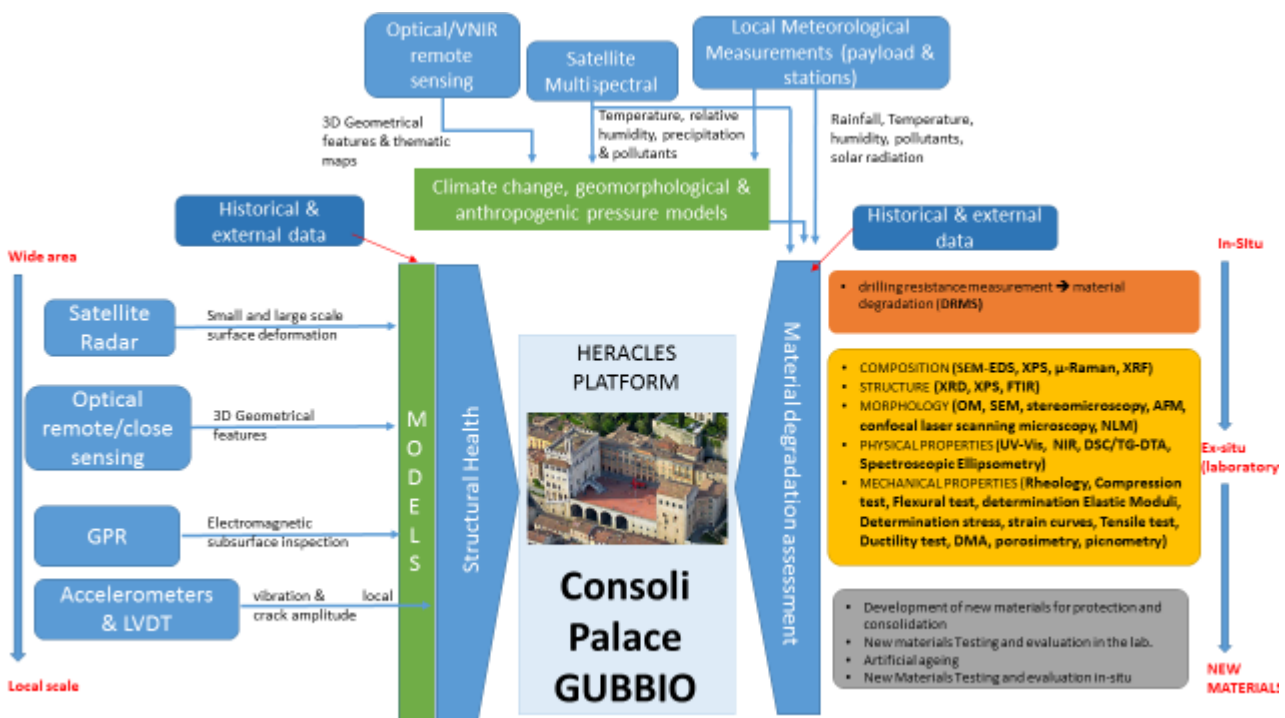

Figure 68: Systematic protocol flow view for Gubbio Consoli Palace

5.2 Heraklion

The Heraklion monuments studied in HERACLES, namely the Venetian sea-fortress of Rocca a Mare (Koules) and the Knossos Palace, are facing a multi-risk scenario with threats coming from the effects of the sea, pollution, and sudden temperature changes causing construction materials weathering.

In particular, the Venetian sea-fortress of Koules is significantly affected by a number of problems related to sea-waves impact and coastal flooding, which in addition to the degradation of the monument surfaces, induce effects which severely endanger the structural integrity of the monument. For instance, upon intense weather conditions, sea-waves may cause the displacement of breakwater modules with a consequent damaging impact to the monument itself and its



surrounding area (see also Figure 69). Also, high speed southern winds, carrying sand, create a sandblasting effect on stone surfaces, increasing the weathering phenomena.

Climate change effects (heavy rainfall events) in combination with increasing pollution levels are also responsible of a number of risks related to degradation of the monument building and/or conservation materials. The intensification of rainfalls including acid rains, in combination with the local extreme winds results into weathering- dissolution of the carbonaceous stones that have been used as building materials, as well as, in alveolar disaggregation (i.e. in Koules). Moreover, the high concentration of pollution levels is responsible for the accumulation of black encrustations on the exposed surfaces of both monuments thus, inducing collateral problems that highly affect their integrity. In this respect, one of the most important issues is related to the decay and degradation of a peculiar material of Knossos Palace, i.e. the mineral gypsum or selenite. Another important issue for both the Heraklion monuments is the appearance on their surface of extraneous materials such as efflorescence crusts and biodegradation products, which are both associated with increasing levels of moisture, air pollution and temperature cycles variation.

To efficiently tackle these issues the following guidelines for monitoring have been suggested and optimized for the particular needs of each monument.

5.2.1 Venetian sea fortress - Koules

In this section, issues related to the Venetian sea fortress - Koules are described.

5.2.1.1 STRUCTURAL ISSUES

The structural issues concerning the Venetian sea fortress - Koules will be addressed considering different aspects, as detailed below in the following sub-sections.

5.2.1.1.1 *The aim of the diagnostic and analytical strategy*

One of the main structural issues in the sea-fortress of Koules is the impact from the sea, particularly the wave intensity, but also extreme weather phenomena, such as heavy rains and winds. All these phenomena are strictly related with the climate change and affect directly the building materials of the monuments/assets (dissolution and alveolar disaggregation of the sandstones) or their surrounding area (i.e. damage due to the displacement of breakwater structures by intense wave impact).



Figure 69: Example of structural risks due to the impact of big pieces of rock (highlighted in the yellow circle) from the breakwater structures upon intense wave events



Furthermore, another structural issue of the Koules sea fortress indirectly derives from the transportation and accumulation of soluble salts. Apart from the aesthetic degradation issue of the stone surfaces, through the formation of salt efflorescence, an important structural issue arises and is related to the loss of the original material due to the “salt hydration distress” (SHD). This term, suggested by the University of Crete to best describe the process, is related to the repeated reconversions of a salt between its anhydrous and hydrated forms. For example the conversion of anhydrous sodium sulfate (thenardite) to the decahydrate (mirabilite) involves an expansion of 317%. To study this phenomenon DRMS measurements will take place in-situ.

5.2.1.1.2 Selected zones and elements of significance

In Figure 70 the areas of interest that are related to the structural integrity of the monument and object of the HERACLES project are indicated.

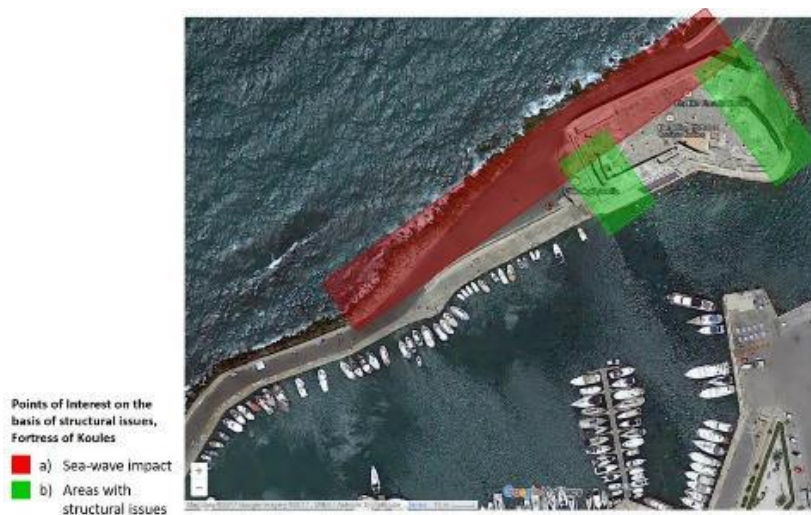

Figure 70: Areas of Interest at the surrounding area of Koule

The Area in green (b) needs the main attention due to the action of the waves that directly affects the north-west part of the fortress.

5.2.1.1.3 Outline of the sensing, diagnostic and analytical methodologies

The impact of waves on the fortress will be addressed as follows:

The climatic effects will be modeled in terms of wind distribution with regional scale modelling tools. These tools are generally built based on long-term, raw-spatial, space-borne, satellite data. By using the appropriate modelling techniques the satellite data are calculated on a 12 km by 12 km grid over the areas of interests.

Local Meteorological Station data and the wave gauges deployed in the area of the monuments will be used to correct the mesoscale data with the aim to minimize the computational error and providing a good evaluation of the local current climatic conditions.

Waves and wave-induced effects will be computed by means of a third-generation wave model, which explicitly represents all relevant physical data for the development of the sea state in two dimensions. Using available input data, the wave model simulates random, short-crested wind generated waves in the near-shore zone, which extends from the coast to several tens of kilometers into the sea.



As in the case of Consoli Palace in Gubbio, X-Band VHR SAR data on ascending and descending passes will be processed with the PSP method to achieve deformation measurements on the fortress and the pier close to the structure. The application of the TMS processing methods is also considered for its potential capability to provide more clear indication about the deformation of the asset of interest and particularly on its vertical walls.

A detailed analysis will be carried on integrating also the different data collected on site and including the structural analysis, to identify the main structural issues and to help in the prioritization process of the preservation actions to be undertaken. UNIPG will carry on a local short-term base (i.e. one day, repeated in time) microclimate in-situ monitoring campaign by means of portable equipment (i.e. environmental payload) able to continuously collect: air temperature, relative humidity, surface temperature, air quality parameters (CO₂), air velocity, etc. Such local monitoring campaign will allow to characterize the local microclimate in the proximity of the testbed areas. In fact, a detailed post-processing of the monitored data will allow to provide geo-referenced maps of the spatial and temporal trends of the main microclimate parameters in the area. Furthermore, the collected data will be used for the calibration and validation of the microscale microclimate model in the area which will be implemented by means of a dedicated software, namely Envimet. The model will be useful to simulate not only the current local microclimate conditions but will allow to predict future microclimate scenarios, by implementing climate change global scale models as the ones elaborated by the IPCC and included in the “4th Assessment report of IPCC” [21]. The analysis will be important to correlate peculiar and/or extreme microclimate conditions to material degradation phenomena.

5.2.1.2 MATERIALS

Different stone deterioration phenomena in Koules fortress include detachment, flaking, friability of masonry, partial or total loss of material, single cracks and multiple cracks connected in network. Alveolar patterns are also observed on all areas of the monument, both indoors and outdoors. Such weathering effects have a major impact on the deterioration of the stone; initially, detachment of the grain aggregates occurs and then deep interconnected cavities are formed. The result is the irregular loss of stone material, which follows the alveolar weathering pattern.

Cracks are also present in areas shown in Figure 71 (at “sperone” area, the room next at the right side of the main entrance).

One of the most important problem of the Koules sea fortress, directly connected to environmental issues, is the transportation and consequent accumulation of soluble salts. The problem has two distinct effects: the aesthetic degradation of the stone surfaces through the formation of salt efflorescence and the loss of original material due to “salt hydration distress” (SHD), as above mentioned.

5.2.1.2.1 *The aim of the diagnostic and analytical Strategy*

At the Koules sea-fortress the material analysis strategy refers to the monitoring and analysis of the crusts and accumulations, which are present on the monument due to pollution and climatic change effects as previously discussed. Emphasis is given on:

- a. **the black deposits** accumulated on the surfaces and due to intense environmental pollution
- b. **bio-degradation** due to the biological activity on the surface, due to the increasing levels of moisture, air pollution and temperature cycle variations.
- c. **efflorescence salts** (already extensively described)





Our strategy will focus not only on the characterization of the degraded materials but also on the understanding of the degradation mechanisms, as well as, on how these processes evolve in correlation with the pollution and extreme weather conditions.

5.2.1.2.2 Selected zones and elements of significance

In the case of Koules sea-fortress the risks related to materials condition and degradation are related to changes due to pollution rates (composition and deposition rates of particulates), as well as to the rainfall activity (chemical composition and severity of acid rains). Immediate effects are stone erosion and accumulation of black crusts, which get significant and endanger the aesthetic and the longevity of the monument.

Figure 71 shows the areas of interest for the HERACLES project. In this images the labels with different colours indicate the different problems to address. These areas will represent also the zones to monitor and where the sampling will be carried on. In the same areas, in-situ tests with the portable instruments (mapping the presence of the crusts and follow their evolution during time) are foreseen.



Figure 71: Map indicating the areas with different problems to be monitored and studied

5.2.1.2.3 Outline of the sensing, diagnostic and analytical methodologies

The meteorological station data will be used in Koules both for coastal and atmospheric hazard evaluation. The meteorological station will provide online time-series data for external temperature, humidity, wind speed and direction, solar radiation and UV Index, pressure and rainfall. All provided data can be correlated to the corresponding satellite data distributions in the area, for calibration and correction purposes. Wind speed and direction, together with barometric pressure and temperature, will be used to make short-term evaluation of the wave height and wave period, significant for the areas of interest. Long-term evaluations can be done based on the satellite data distributions. Also,





the data from the meteorological station can be useful to follow and investigate sea spray dispersal, leading to salt and tar deposits, mostly on the northern walls of the monument.

As far as the materials are concerned, the information provided by the meteorological station on temperature and humidity seasonal and temporal variation between day and night will be of high importance for supporting the local decision makers in preservation actions.

Additionally, a number of portable instruments will be also employed in-situ to fast screen the different crusts as regards their composition and map their presence and evolution. Portable Raman and LIBS instruments on the basis of the detailed information acquired through laboratory studies, will screen in-situ the various crusts. In parallel, spectral imaging and 4D volume/surface topography will be employed to map the different areas and to monitor their progress, in correlation with the pollution and extreme weather events.

The analytical and diagnostic strategy for the Koules material issues involves a number of techniques able to give information related to chemical, mechanical and thermo-physical properties of the building materials as well as of the crusts and accumulations present on their surfaces.

The mechanical and thermo-physical characterization, similarly to the Gubbio case, will allow gathering information on the materials conservation state with emphasis to their resistance to mechanical and thermal stress. The techniques involved have been reported and briefly described in section 4. Here, DRMS technique will be used. The collection and analysis of the drilling residue from several and well defined interval depths will give a quantitative, as well as a qualitative estimation of the salts presence beneath the surface of the stone. Moreover, through DRMS, the current preservation state (surface degradation) of several stones of the same lithotype will be evaluated with respect to the different environmental conditions inside the fortress.

For the material chemical, mineralogical and morphological study, a multi-analytical approach is suggested, as already reported in details in Section 5, guaranteeing in that a way a complete characterization of the degraded materials and their degradation mechanisms.

5.2.1.3 SYSTEMATIC PROTOCOL RELATED TO THE DIAGNOSTIC AND ANALYTICAL STRATEGIES FOR HERAKLION – KOULES FORTRESS

In the previous paragraphs all the criticalities affecting the Koules Fortress in Heraklion have been briefly reported, as well the methodologies suitable to study this CH asset.

In the following picture (Figure 72), a summary of the systematic protocol proposed for the Koules Fortress in Heraklion, is presented.

The aim is to provide a clear and easy visualization of all the phases/actions necessary to assess the current situation of the Koules Fortress in Heraklion.



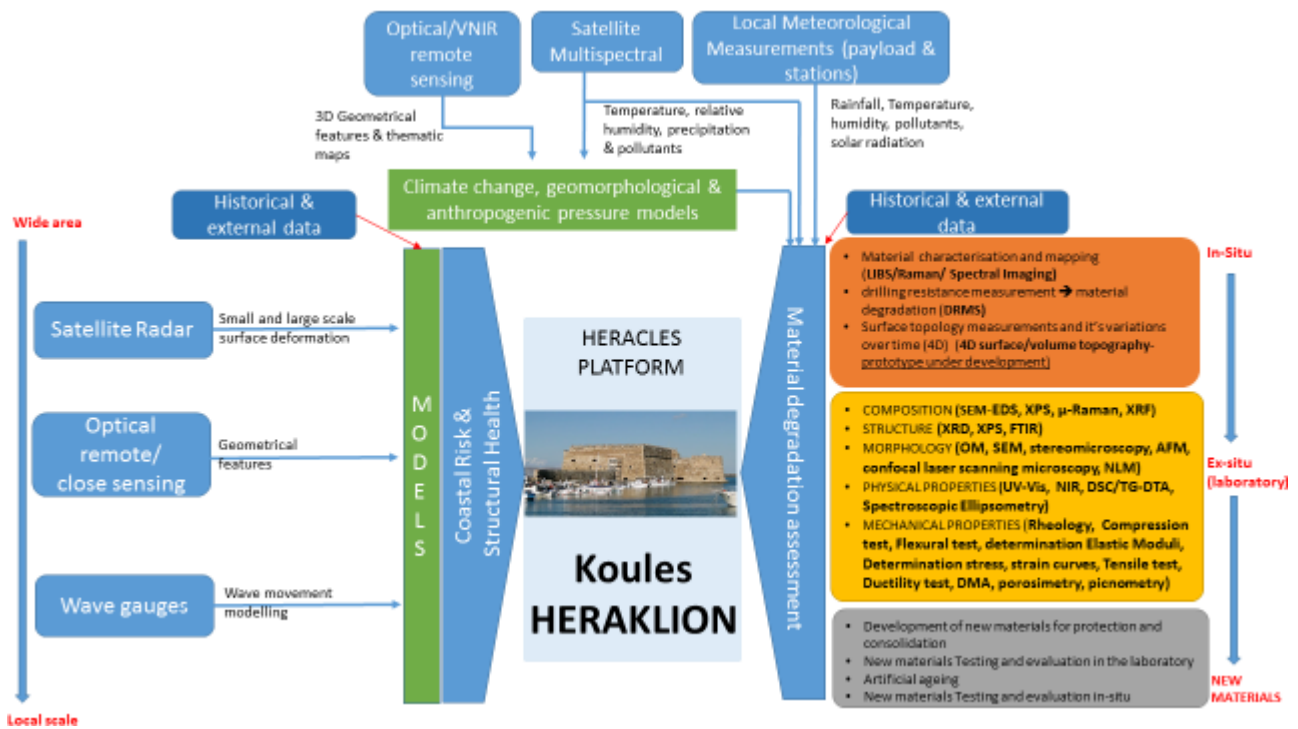

Figure 72: Systematic protocol flow view for Heraklion, Koules Fortress,

5.2.2 Archaeological site of Knossos Palace

In Figure 73 the areas of interest that will be studied at the Knossos Palace within HERACLES are defined.



Figure 73: The five areas in the Knossos Palace to be studied in HERACLES: 1. West Magazines, 2. Tripartite Shrine, 3. East Wing, 4. South House and 5. Magazine of Giant Pithoi

The five areas are:

1. **West Magazines**, a partially sheltered area, constituted by eighteen store rooms, exposed in the west site of the Palace from North to South, with intense temperature variations between day and night. The area has a large number of selenite blocks exposed to the direct effect of the weather.
2. **Tripartite Shrine**, a sheltered area with prevalent risk coming from moisture. Moisture penetrates through the roof of the *Piano Nobile* (through openings at the contact points between selenite and the reinforced concrete) towards the lower rooms. There, the Minoan selenite pillars are subjected to weathering due to the humidity, while other crusts due to efflorescence are also identified.
3. **East Wing**, a restored sheltered area which, as the Tripartite Shrine, presents similar weathering problems concerning materials, due to the moisture flowing through the reinforced concrete roof. Effects from creeping species and crack patterns are significant.
4. **South House**, this part of the Palace presents a significant number of structural and material problems of interest for HERACLES: intense moisture, soil movement, static problems, collapses, cracks and delamination of concrete due to the soil movement, falling of trees due to the presence of groundwater.
5. **Magazine of Giant Pithoi**, a restored sheltered store room in the NE area of the Palace, which presents static problems and cracks.

5.2.2.1 STRUCTURAL ISSUES

The structural issues concerning the Knossos Palace will be addressed considering different aspects, as detailed below in the sub-sections.

5.2.2.1.1 *The aim of the diagnostic and analytical Strategy*

The diagnostic strategy to be followed for the archaeological site of Knossos as regards its structural integrity is twofold:

- the dangerous effects due to the climate impact on the monument will be studied,
- the structural integrity of the cement reinforcements applied to the monument upon the reconstruction works of sir A. Evans will be investigated.

To summarise, creeping effects, meteorological factors as heavy rains, humidity, existing deformations and crack patterns, static problems, cracks and delamination of concrete, falling of trees due to the movement of groundwater are very significant in the west, south and east side of Knossos Palace.

5.2.2.1.2 *Selected zones and elements of significance*

In Figure 74 are defined the areas of interest affected by the structural issues to be studied at the Knossos Palace within HERACLES project.



Figure 74: Knossos Palace areas showing structural issues under investigation in HERACLES project. The different issues are evidenced with different colours as reported in the legenda

These structural issues located in the monument are:

1. Significant deformation of **reinforced concrete** at the sheltered part of West Magazines.



2. Weathering problems concerning the **contact points between selenite and the reinforced concrete**, due to the moisture flowing through the roof at the East Wing. Also creeping effects and cracking patterns are significant.

3. **Static problems, collapses, cracks and delamination** of reinforced concrete in the South House.

4. **Static problems and cracks**, especially on the north wall of the restored sheltered area at the Magazine of Giant Pithoi.

5.2.2.1.3 Outline of the sensing, diagnostic and analytical methodologies

The area will be monitored by the use of radar satellite and will involve the processing of HR as well as VHR data: both processing techniques are available in HERACLES (PSP and TMS) and will be used. Specifically, HR data acquired by Sentinel 1, operating at C-Band will be processed via the PSP technique to gather possible the information about the hydrogeological risk associated with soil and ground movements in the area. Criticalities associated with the vegetation coverage, which hinders the visibility of the collapses from a radar are however preliminarily considered. Although characterized by a lower resolution with respect to the VHR data, the use of radiation at C-Band, acquired from the Sentinel 1 (HR data), results less influenced by the presence of vegetation, and the signal coming from the ground is consequently less perturbed. X-Band VHR data will be processed both with the PSP method, as well as with the TMS processing method which is better targeted for reconstructing and monitoring structures developed vertically.

5.2.2.2 MATERIALS

The extensive use of mineral gypsum (selenite) is a very peculiar feature of the architecture of the Minoan palaces of Knossos, producing a particular iridescence as reflected light from the monument surfaces. This stone is originating from a local quarry and used both as ornamental and building element. The use of selenite as a building material is not very common in antiquity due to its susceptibility to weathering. The effects of climate changes and pollution on the structural integrity of these selenite components are particularly critical and thus their weathering state assessment is mandatory.

In the case of the mineral gypsum, the main parameter to be evaluated via DRMS is the depth of degradation (loss of cohesion between crystal aggregates). DRMS will be initially used as a mechanical test to evaluate the preservation state of the original materials as well as to assess the performance of the consolidating compounds. Specifically, it will be possible to estimate the necessary penetration depth of the consolidating material. Additionally, based on the high depth resolution of the DRMS, the drilling residue (dust) that will be collected from distinct interval depths, will be examined in the laboratory to detect and evaluate the formation of the consolidating compounds both on morphological (SEM) as well as on chemical level (spectroscopic analyses, XRD, EDS). In terms of surface coordination chemistry, it will be possible to evaluate the optimization and hence the performance of different consolidants, with respect to the depth of penetration and development of consolidating compounds inside the stone mass.

Apart from the degradation of selenite the project aims also to study other materials such as mortars (the modern ones used for restoration as well as the mortars applied upon the Evans reconstruction in the beginning of the 20th century, now considered as historical), with the aim to evaluate their performance against weathering and the other effects of climate change.





5.2.2.2.1 *The aim of the diagnostic and analytical Strategy*

The suggested analysis strategy for the Knossos materials refers to the monitoring and analysis of the original materials as well as that ones used for reconstruction. Furthermore, crusts and accumulations due to pollution and climate change combined effects will be object of this study. Particular attention will be given to:

- a. the unique feature of **selenite**, which is particularly sensitive to a number of factors, humidity being the most important.
- b. the **mortars**, ancient as well as historical ones (from the Evans reconstruction works), with the aim to evaluate their performance against weathering and other effects of climate change
- c. **efflorescence salts** in sheltered areas due to incompatibility of adjacent materials that have been applied in different periods and conditions
- d. **concrete** (used by Evans and more recent ones)

As stated in the case of the Koules and the Gubbio monuments, the suggested strategy will assess the status of materials, looking for the reasons producing these degradation phenomena, with the aim to monitor their progresses and trying to prevent them. The above studies will always be based on the correlation of the increasing pollution and extreme weather conditions data.

5.2.2.2.2 *Selected zones and elements of significance*

Having defined to address the effects produced by rainfall activity (chemical composition and severity of acid rains) and pollution (composition and deposition rates of particulates) the areas selected to be monitored and where materials will be analysed, are shown in Figure 75.

1. **Selenite blocks at the West Magazines**. These are located in the west site of the Palace from North to South, in an area with intense temperature variations between day and night.
2. **The selenite pillars at Tripartite Shrine** which are affected by weathering due to humidity. This is a sheltered area with dominant presence of moisture. Moisture penetrates through openings at the contact points between selenite and the reinforced concrete towards the lower rooms.
3. In the same area **other crusts (i.e. efflorescence)** are also identified.
4. **Weathering problems of the materials at the East Wing**; a sheltered area, which presents significant material weathering problems due to the moisture through the roof.
5. **Intense moisture weathering problems and efflorescence salts at the South House**. The area has also a number of selenite blocks exposed to the weathering

In these same areas in-situ tests with the portable instruments, that will map the presence of the crusts and follow their evolution, are also foreseen.



Figure 75: Areas in the Knossos Palace to be studied in HERACLES project, on the basis of materials and effects: the meaning of the different colours is indicated in the legenda.

5.2.2.2.3 Outline of the sensing, diagnostic and analytical methodologies

The meteorological station will provide time-series data on external temperature, humidity, wind speed and direction, solar radiation and UV Index, pressure and rainfall. All provided data can be correlated with the corresponding satellite data distributions in the area, for calibration and correction purposes.

In Knossos, where erosion problems are more evident, rainfall time-series will clearly indicate rain duration and severity patterns in the area.

The wind speed and direction measurements are important for two reasons. First, they will be used for weather pattern predictions including particulate matter and pollutants transport in the area. Second, they will support in estimating how severe wind-speed outbreaks, especially those related with strong south winds, influence the local vegetation (e.g. large trees surrounding Knossos) on a yearly basis and they will help in estimating the vegetation stress mapping that will be performed using satellite imaging. Also, the ground based data from the meteorological stations will support a finer calibration of the satellite data.

The information provided by the meteorological station on temperature and humidity seasonal and temporal variation between day and night, will be of great importance in supporting the decision making process for the preservation of the monument.

Additionally, as in Koules, a number of portable instruments (Raman, LIBS and 4D volume/surface topography) will be also employed to fast screen in-situ the different encrustations, as regard to their composition and mapping their presence and evolution, correlating them to the pollution and to extreme weather events.



To summarise, the analytical and diagnostic strategy for Knossos site materials involves a number of techniques that will give information on their chemical, mechanical and thermo-physical properties. The different classes of materials to address has been already discussed.

The mechanical and thermo-physical characterization, similarly to Koules and Gubbio cases, will allow to get information on the conservation state of the involved materials with emphasis to their resistance to the mechanical and thermal stress. The techniques involved have been reported and briefly described in section 4.

The multianalytical approach will be that one applied also in Knossos, since it will assure physico-chemical and morphological characterization combining elemental analysis with molecular information. The techniques discussed in section 4 will be available to study and identify the different degradation phenomena on the basis of the specific requirements of the site.

5.2.2.3 SYSTEMATIC PROTOCOL RELATED TO THE DIAGNOSTIC AND ANALYTICAL STRATEGIES FOR HERAKLION – ARCHAEOLOGICAL SITE-KNOSSOS PALACE

In the previous paragraphs all the criticalities affecting the Knossos Palace in Heraklion have been briefly reported, as well the methodologies suitable to study this CH asset.

In the following picture (Figure 76), a summary of the systematic protocol proposed for the Knossos Palace is presented.

The aim is to provide a clear and easy visualization of all the phases/actions necessary to assess the current situation of the Knossos Palace.

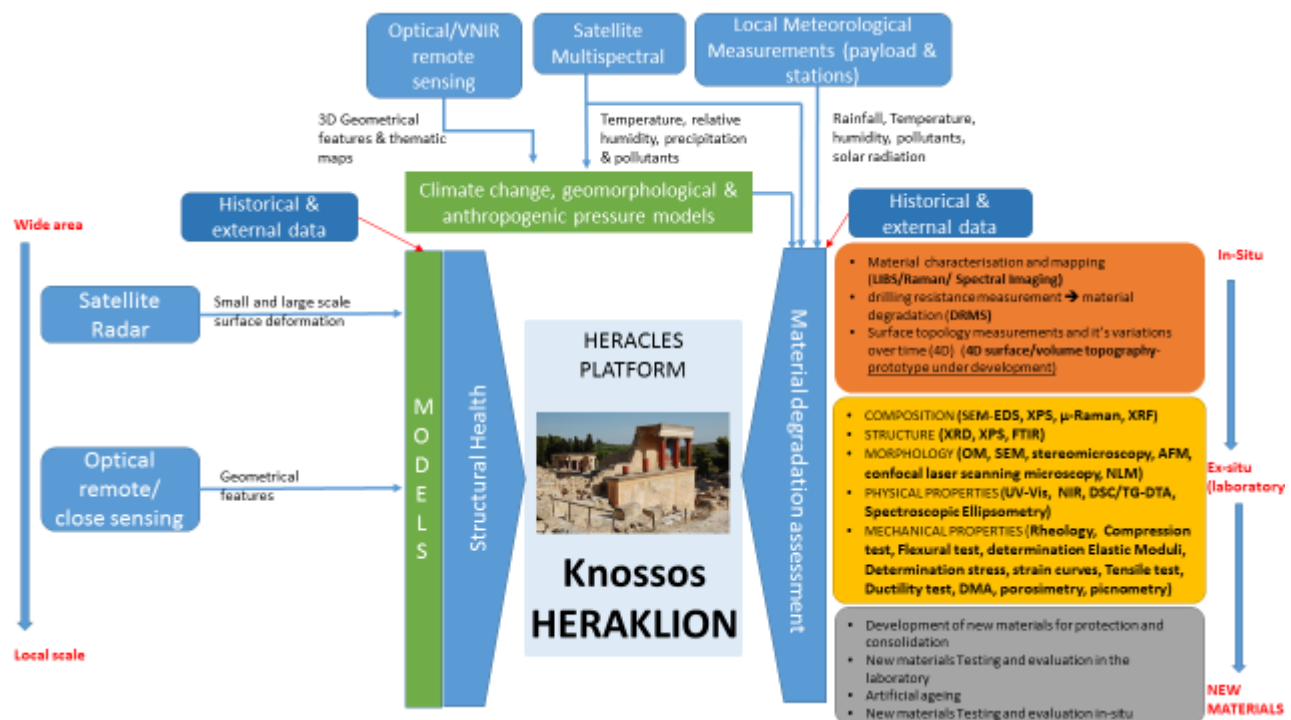

Figure 76: Systematic protocol flow view for Knossos Palace in Heraklion



6 Conclusions

The present document aims at providing the definition of protocols related to the diagnostic and analysis strategies to be adopted in HERACLES for the investigation of the assets/monuments of interest in the project test-beds.

To achieve this goal, an intensive work has been carried out, to assess in detail important aspects to be considered for the protocols.

First, the end-users needs related to the HERACLES test-beds have been closely examined, to assure an approach really effective. This part has been extensively treated and was matter of the HERACLES deliverable D1.2-MS1.

At the same time, a survey of the methodologies and techniques for CC impact evaluation and risk and vulnerability analysis was also performed (HERACLES deliverable D1.3).

Based on the end-users requirements and on our investigations and surveys on-site, one of the key elements necessary for an effective action to face the different criticalities and problems on areas, structures and materials and to propose tailored solutions is to adopt an integrated monitoring technologies approach from the wide area surveillance till the single CH asset/monument including the surrounding territory.

Taking into account the different problems evidenced in the different test-beds, the more suitable techniques to assess the environmental/structures/materials status have been identified and selected.

The HERACLES diagnostic and monitoring tools are characterized by the use of a large number of sensors operating at different scales, with multi-depth capabilities and tailored to the measurement of different parameters, as well as of methods for the analysis of materials able to acquire complementary information. Accordingly, in order to provide an overview of the characteristic and peculiarities of each sensor and diagnostic and analytical methods, a synthetic description of each technology has been provided (Section 4).

Structural and material degradation issues are of primary importance for the test-beds of interest of the project. Referring to the identified risks, a general protocol for using sensors and techniques has been then provided for each cultural heritage asset: the medieval Walls and the Consoli Palace in Gubbio and the Venetian Fortress (Koules) and the Knossos Palace in Heraklion.

The document has been related to remote and close sensing as well as to ex-situ (i.e. laboratory) techniques for the investigation of weathering and erosion. In-situ diagnostic protocol for quick assessment and monitoring of the weathering state are the main subject of the companion Deliverable D3.2.

To assure a homogeneous approach, the same investigation techniques will be used in the different areas. Anyway, since many specificities and peculiarities related to the sites are present, systematic protocols related to the diagnostic and analytical strategies for each different monument to be studied on the basis of the different structures, materials and weathering states are also provided in Section 5. Even if for these reasons a univocal protocol is not given, it has to be underlined that a general approach of general validity has been established and provided. It is schematically presented in Figures 60 and 61 and discussed at the beginning of Section 5 in the present document.

More in detail, for the HERACLES test-beds, protocols specifically tailored for their specific needs are discussed in Section 5.1 and 5.2 (and related subsections) in terms of their structural issues and materials.





Further details, specifically for remote and in-situ monitoring, will be provided in the forthcoming deliverables D3.3 and D3.4.

Measurement activities are framed in the context of WP3 and WP8 (demonstration activities) as well. The protocols, object of the present document, should hence be interpreted as guidelines to be further assessed and refined at a later stage. The subsequent refinement will be also beneficial for the exportability and generalization of the operational procedures related to the risk management connected to CH assets and for improvements of CH resilience, with reference to other monuments. Along this line, a fundamental contribution is associated to the activities of WP4 concerning the design of new material for restoration and remediation and to the activities of WP7 concerning the policies and procedures for end-users.

In conclusion, to underline the potential transition from the LOCAL to the GLOBAL dimension and applicability, in Figure 77 is visualized the “GLOCAL” HERACLES approach which guarantees a situation awareness, always updated, allowing a prevision of the Climate Change effects at different time and spatial scales.

In such a way, this approach will be a suitable supporting tool for prioritizing decisions and planning the resulting actions on a regular maintenance and prevention.

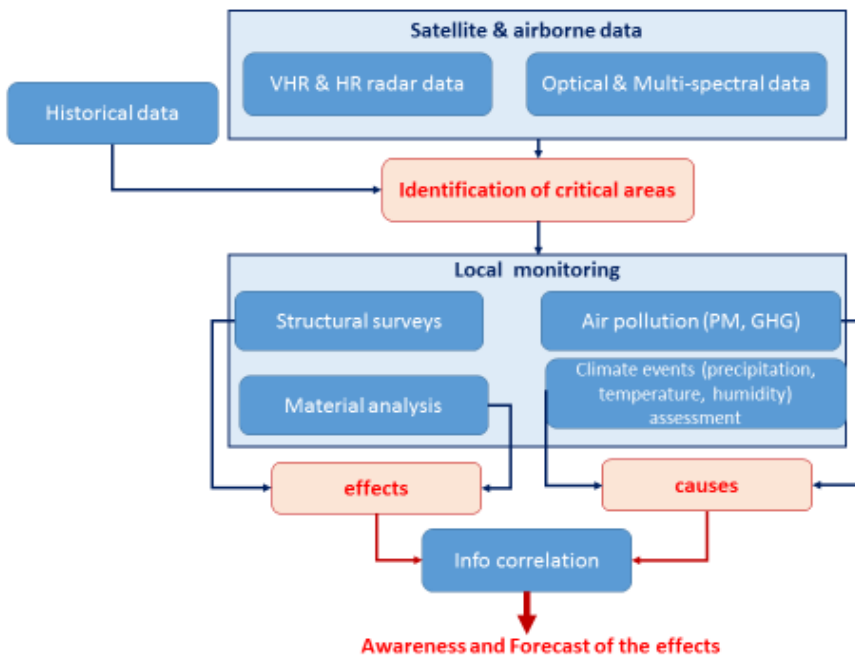

Figure 77: Visualisation of the “GLOCAL” HERACLES approach



7 Selected sources and documents

1. M. Costantini, S. Falco, F. Malvarosa, F. Minati. A New Method for Identification and Analysis of Persistent Scatterers in Series of SAR Images. *IEEE Geosci. Remote Sens. Symp., IGARSS 2008*, **2(II)**, 449-452, 2008.
2. G. Fornaro, F. Lombardini, A. Pauciuolo, D. Reale, F. Viviani, Tomographic Processing of Interferometric SAR Data: Developments, applications, and future research perspectives. *IEEE Signal Process. Mag.*, **31(4)**, 41–50, (2014).
3. H.EISENBEISS, "UAV photogrammetry", Phd Thesis, 2009
4. H. Liang. Advances in multispectral and hyperspectral imaging for archaeology and art conservation. *Applied Physics A*, **106(2)**, 309-323, 2011.
5. C. Fischer and I. Kakoulli. Multispectral and hyperspectral imaging technologies in conservation: current research and potential applications. *Studies in conservation*, **51(1)**, 3-16, 2006.
6. V. Papadakis, A. Loukaiti, and P. Pouli. A spectral imaging methodology for determining on-line the optimum cleaning level of stonework. *Journal of Cultural Heritage*, **11(3)**, 325-328, (2010).
7. J. Baker, V. Kantarelou, A.G. Karydas, R.E. Jones, P. Siozos, D. Anglos, B. Derham, The height of Denier Tournois minting in Greece (1289-1313) according to new archaeometric data, *Annu. Br. Sch. Athens* 2017, In press. DOI: 10.1017/S0068245416000113
8. Z.E Papiaka, A. Philippidis, P. Siozos, M. Vakondiou, K. Melessanaki, D. Anglos, A multi-technique approach, based on mobile/portable laser instruments, for the in-situ pigment characterization of stone sculptures on the island of Crete dating from Venetian and Ottoman period, *Herit. Sci., Heritage Science* (2016) 4(15). DOI: 10.1186/s40494-016-0085-2
9. P. Westlake, P. Siozos, A. Philippidis, C. Apostolaki, B. Derham, A. Terlix, V. Perdikatsis, R. Jones, D. Anglos, Studying pigments on painted plaster in Minoan, Roman and Early Byzantine Crete. A multi-analytical technique approach. *Anal. Bioanal. Chemistry*, **402** (2012) 1413–1432.
10. D. G. Papazoglou, V. Papadakis, and D. Anglos, In situ interferometric depth and topography monitoring in LIBS elemental profiling of multi-layer structures; *J. Anal. At. Spectrom.* **19**, 483 (2004)
11. V. M. Papadakis, A. Stassinopoulos, D. Anglos, S. H. Anastasiadis, E. P. Giannelis, and D. G. Papazoglou, Single-shot temporal coherence measurements of random lasing media; *J. Opt. Soc. Am. B-Optical Phys.* **24**, 31 (2007).
12. Y. Arieli, S. Epshtein, I. Yakubov, Y. Weitzman, G. Locketz, and A. Harris, Surface measurements by white light spatial-phase-shift imaging interferometry; *Opt. Express* **22**, 15632 (2014).
13. G. Padeletti, G. M. Ingo, A. Bouquillon, S. Pages-Camagna, M. Aucouturier, S. Roehrs, P. Fermo, First-time observation of Mastro Giorgio's masterpieces by means of non-destructive techniques, *Applied Physics A*, **83**, (2006) 475
14. P. Fermo, G. Cappelletti, N. Cozzi, G. Padeletti, S. Kaciulis, M. Brucale, M. Merlini, Hydrophobizing coatings for cultural heritage. A detailed study of resin/stone surface interaction, *Applied Physics A*, **116**, (2014), 341
15. G. Padeletti, P. Fermo, A scientific approach to the attribution problem of Renaissance ceramic productions based on chemical mineralogical markers, *Applied Physics A*, **100**, (2010), 771
16. J. Pires, A. J. Cruz, Techniques of thermal analysis applied to the study of cultural heritage ; *Journal of Thermal Analysis and Calorimetry*, **87**, 411 (2007)





17. G. Filippidis, G.J. Tserevelakis, A. Selimis, C. Fotakis, Nonlinear imaging techniques as non-destructive, high-resolution diagnostic tools for cultural heritage studies; *Applied Physics A: Materials Science & Processing*, **118**, 417, (2015).
18. G. Latour, L. Robinet, A. Dazzi, F. Portier, A. Deniset-Besseau, M.C. Schanne-Klein, Correlative Non-linear Optical microscopy and infrared nanoscopy reveals collagen degradation in altered parchments, *Scientific Reports*, **6**, 26344, (2016).
19. S. Psilodimitrakopoulos, E. Gavgiotaki, K. Melessanaki, V. Tsafas, G. Filippidis, Polarization Second Harmonic Generation Discriminates Between Fresh and Aged Starch-Based Adhesives Used in Cultural Heritage ; *Microscopy and Microanalysis*, **22**, 1072, (2016)
20. J.M. Madariaga, Analytical chemistry in the field of cultural heritage, *Anal. Method*, **7**, 4848, (2015) and references cited therein
21. 4th Assessment report of IPCC can be available at http://www.ipcc.ch/publications_and_data/publications_and_data_reports.shtml

